



**EN**

**IST-1408.CE02.02**

File: IST-1408.CE02.02\_CE408-EN (30.11.2016).docx

# **GAS CONTROL UNIT**

## **CITY**

### **CE408P**

**4 to 8 Inputs 4÷20mA**

## **USER INSTRUCTIONS**

**TECNOCONTROL S.r.l.**

Via Miglioli, 47 20090 SEGRATE (MI) Italy- Tel. (+39) 02 26922890 - Fax (+39)02 2133734

http: [www.tecnocontrol.it](http://www.tecnocontrol.it)

e-mail: [info@tecnocontrol.it](mailto:info@tecnocontrol.it)



## Please read and keep care of this manual and the manual of installed sensors too.

All documentation relating to gas detection plant should be preserved, because it contains the procedures to be used during the routines verification and / or during the periodic calibration. We recommend that you always complete the [Setup Memorandum Tables in the last pages of this manual](#). This will facilitate any possible change to the configuration and/or in case of additional sensors, and operations and maintenance service

### INFORMATION AND WARNINGS OF USE

The CE408 is a control unit for gas alarm systems up to 8 independent detection points. The simple installation and easy configuration via the buttons make the unit suitable for use in many areas, both civil and industrial.



It should be noted that inappropriate use or lack of maintenance can affect the operation of the device and thus preventing the proper activation of alarms with potential serious consequences for the user.

TECNOCONTROL disclaims any responsibility if the product is misused, altered or not as planned or outside the rated operating limits or put in work incorrectly.

The choice and use of the product are the sole responsibility of the individual operator.

The rules, laws, etc.. mentioned, are the ones valid on the date of issue. In any case, must be observed all applicable national regulations in the country of use.



The information contained in this document are accurate, current at the date of publication, and are the result of continuous research and development, the specifications of this product, and what is indicated in this manual may be changed without notice.



The Central has a clock with the automatic DST change. In the absence of power supply, the clock works with the lithium battery (on the board in the cover), its life, in normal operation is over 5 years.

If the lithium battery is exhausted and the central remained completely without power, at start up, you will need to enter the correct date and time ([see page 29](#)) and then the battery must be replaced soon with a new one.

### NOTES FOR READING INSTRUCTION

<b>CE408P</b>	Control unit for 4 gas detectors, expandable up to 8 with 1 ES404. Equipped with # 5 relay outputs expandable to 9 with 1 ES4014. The unit has also # 1 Logic Input.
<b>ES404</b>	Expansion card with 4 inputs (4÷20mA) for gas detectors.
<b>ES414</b>	Expansion card with 4 relay outputs.
<b>SENSORS</b>	It is the name that, for simplicity, are indicated the various models of Remote Gas Sensors, with current output 4 to 20mA, that can be connected to the CE408P.
<b>FIRMWARE</b>	Program inserted into the microcontroller which controls CE408P functioning.
	Symbol that indicates an important warning in the instructions.
	Symbol indicates information or additional explanation in the instructions.

**Documento / Document name:** IST-1408.CE02.02\_CE408-EN (30.11.2016).docx

**Oggetto / Subject :** CE408P Wall mount Gas Control Unit (housing Giugiaro design)

Rev.	Data / Date	Da / By	Note
0	30/11/2016	UT/FG	Document Edition

## SOMMARIO

<b>DESCRIPTION</b>	<b>5</b>
Fig.1 - <i>CE408P – Wall mount housing</i>	5
<b>CE408P INSTALLATION</b>	<b>8</b>
Fig 2 – CE408P Dimensions and Template for wall mounting	8
<b>OPENING-CLOSING the HOUSING</b>	<b>8</b>
<i>The housing has two sliding internal hinges. To open the case, you must:</i>	<b>8</b>
<b>ELECTRICAL CONNECTIONS</b>	<b>9</b>
<b>POWER CONNECTION</b>	<b>10</b>
Fig 3 – Wiring diagram for Power, Batteries, AUX input and output 9.	10
<b>CONNECTION WITH GAS SENSORS</b>	<b>11</b>
Fig 4 – Wiring diagram for Inputs Sensor 4 to 20mA and relay Outputs	11
NA=NO	11
<b>UNIT'S OPERATION</b>	<b>12</b>
Fig 5 – CE408P Keyboard	12
<b>MAIN MENU</b>	<b>15</b>
<b>RESET</b>	<b>15</b>
<b>SENSORS</b>	<b>16</b>
ENABLE/DISABLE (Level 1)	16
CONFIGURE (Level 2)	17
COPY (Level 2)	20
DELETE (Level 2)	21
MODIFY (Level 2)	22
DETAILS	22
<b>LOGIC INPUT</b>	<b>22</b>
ENABLE/DISABLE (Level 1)	22
CONFIGURE (Level 2)	23
DELETE (Level 2)	23
MODIFY (Level 2)	24
DETAILS	24
<b>ZONES</b>	<b>24</b>
ENABLE/DISABLE (Level 1)	24
CONFIGURE (Level 2)	25
DELETE (Level 2)	26
MODIFY (Level 2)	26
DETAILS	26
<b>EVENTS</b>	<b>27</b>
ALARMS/FAULTS	27
ALL	27
<b>SETTINGS</b>	<b>28</b>
LANGUAGE (Level 1)	28
GENERALS	28
BUZZER (Level 1)	28
DATE and TIME (Level 1)	29
<b>ACCESS MENU</b>	<b>29</b>
ENABLE LEVEL	29
DISABLE LEVEL	30
MODIF. PASSWORD	30

<b>SERVICE</b>	<b>31</b>
ELECTRIC TEST (Level 2)	31
BATTERY (Level 2)	31
SENSORS STATUS (Level 2)	32
START-UP (Level 3)	32
SD CARD	32
UPDATE FIRMWA. (Level 2)	32
Fig.6- Board into housing cover	33
<b>APPENDIX</b>	<b>34</b>
<b><i>CE408 Technical Specifications</i></b>	<b>34</b>
<b><i>TABLE with summary of Fault and Alarm messages.</i></b>	<b>34</b>
<b><i>TABLE 1</i></b>	<b>35</b>
<b><i>List of PRECONFIGURED Sensors with Display and Replaceable Cartridge Sensor</i></b>	<b>35</b>
<b><i>List of PRECONFIGURED Sensors with Display and Replaceable Cartridge Sensor</i></b>	<b>36</b>
<b><i>List of PRECONFIGURED Sensors without Replaceable Cartridge Sensor</i></b>	<b>36</b>
<b><i>TABLE 2 – PRECONFIGURED values for TLV</i></b>	<b>36</b>
<b><i>TABLE 3 – PRECONFIGURED values for use with PARKING-EN (EN50545-1)</i></b>	<b>36</b>
<b><i>TABLE 4 – USED ONLY IN ITALY - Values to be set to use with PARKING-ITA (DM 1.02.1986)</i></b>	<b>37</b>
<b><i>TABLE 3 - Relays operation's PRECONFIGURED parameters.</i></b>	<b>37</b>
<b><i>SETUP MEMORANDUM TABLES</i></b>	<b>38</b>
<b><i>BLOCK DIAGRAM OF MENUS WITH ACCESS WITHOUT PASSWORD</i></b>	<b>41</b>

## DESCRIPTION

**Fig.1 - CE408P – Wall mount housing**

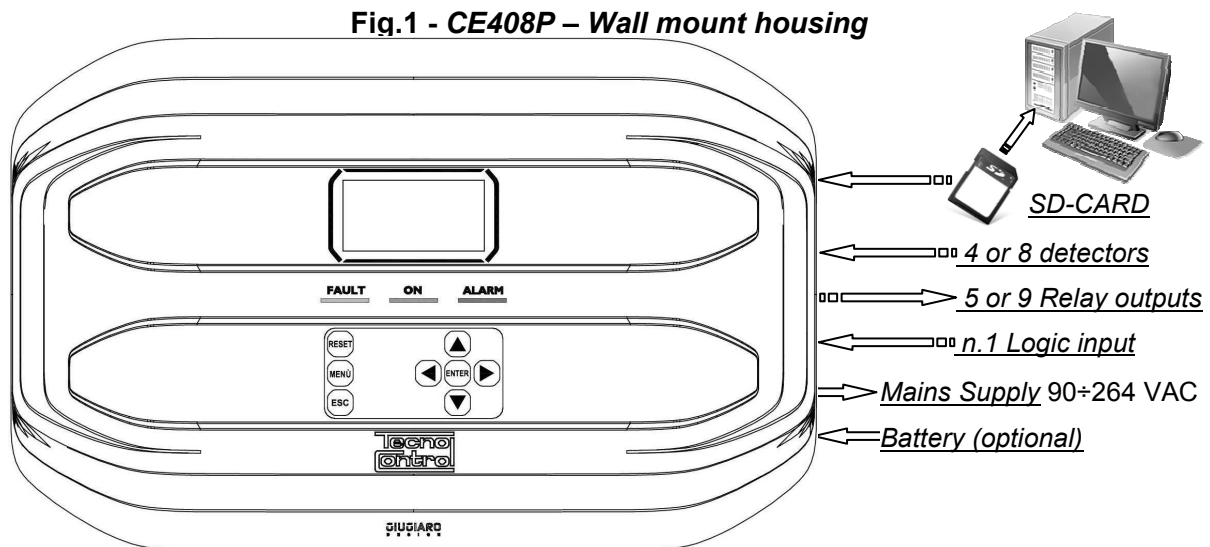

- **The CE408P is wall mount “GIUGIARO DESIGN” housing 379x241x133 mm:**

- **The CE408P can be connected to all of our Gas Detectors (Sensors):**

The CE408 can control up to 4 or 8 remote gas sensors.



From Genn. 2017 the TS282xx (IP65) series, supersede all TS220xx and the TS292xx. (Example: TS292KM will become TS282KM or the TS220EO will become TS282EO).

- Three-Wire, 4÷20mA linear output models with “Replaceable Cartridge Sensor” for:
  - Flammable gases with Catalytic sensor* (20% LEL range) TS292K(IP65) or TS293K(Ex”d”) series.
  - Flammable gases with Pellistor sensor* (100% LEL range) TS292P(IP65) or TS293P (Ex”d”) series.
  - Flammable gases with Infrared sensor* (100% LEL range) TS293I(Ex”d”) series.
  - Toxic gases with electrochemical cell* TS220E (IP65) or TS293E (Ex”d”) series.
  - Carbon dioxide with Infrared sensor* TS210IC2 (IP54), TS220IC2 (IP65) or TS293IC2 (Ex”d”).
  - Oxygen with electrochemical cell* (25% volume range) TS220EO or TS293EO (Ex”d”).
  - With dual sensor for Parking* TS255CB or TS255CN2.
  - Refrigerant gases with Semiconductor sensor* TS220SFx (IP65) series.
- Three-Wire, 4÷20mA linear output models with Display and with “Replaceable Cartridge Sensor” for:
  - Flammable gases with Pellistor sensor* (100% LEL range) TS593P (Ex”d”) series.
  - Flammable gases with Infrared sensor* (100% LEL range) TS593I (Ex”d”) series.
  - Toxic gases with electrochemical cell* TS293E (Ex”d”) series.
  - Toxic gases with electrochemical cell* (25% volume range) TS593EO (Ex”d”).
- Should be connecting all models without the replaceable Cartridge:
  - Refrigerant gases with Infrared sensor* TS210IF (IP42) series.
  - Flammable gases with Catalytic sensor* SE192K (IP65) or SE193K (Ex”d”) series. They can only be used in non-industrial environments, such as boiler rooms.



May be connected, even discontinued models. Detectors three-wire 4 to 20mA linear for flammable gases or those two-wire 4 to 20mA linear for toxic gases or oxygen, produced until December 2008. Or the IR101or IR102 for CO<sub>2</sub> in production until December 2014.



Inputs are configurable for 4÷20mA sensors with referred current to ground and operating characteristics same as our products (unit in %LEL or ppm, minimum operating voltage, absorption, load resistance etc.).

**We accept no liability for any malfunction, failure or damage caused by products not compatible or not we produce.**

- **Each Sensor may be associated with a ZONE:**

The sensors can be grouped into **Zones** (Max 2), which can associate up to 2 relay outputs different for each alarm level and a FAULT.

- **Each ZONE can be set according to operating LOGIC:**

The logic used are the typical logic functions (**AND**, **OR**), management of adjacent sensors (**CORR.CON**, **CIRC.CON**). Note that **PARK-ITA** is a function only for Italy (Italian Ministerial Decree 01/02/1986).

- **Each INPUT (Sensor) is self-protected and has a FAULT signal:**

All sensors inputs are protected against short-circuit or wire breakings. If a short-circuit occurs, the power supply to that input, is automatically stopped (all others continue to work properly). At the same time, the FAULT signal is activated.

- **Each Sensor can be configured in two ways:**

**Preconfigured Setup:** Here you can choose one of the models of our production, ([See list in Table on page 35](#)), which is then automatically set in the configuration recommended by the respective thresholds and relay outputs. It is enough set the output number (relay) to complete the configuration. The manual changes are, however, permitted.

**General Configuration:** Here you can configure any type of sensor (*compatible or a new model not yet listed*), manually entering all parameters.

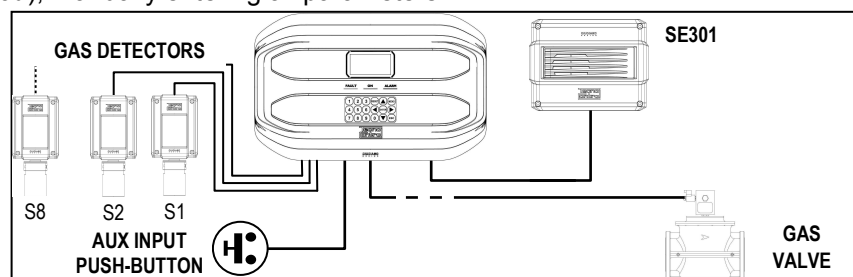

- **The AUX input is configurable and can be associated with a relay output:**

- Can be configured to activate one of the available relays and can be used by devices with NO or NC contact outputs (*gas sensors with a relay contact, smoke sensors, buttons, etc.*).

- **The CE408 can manage up to 5 or 9 Alarm relays:**

Each sensor has three alarm levels (**Threshold 1**, **Threshold 2** and **Threshold 3**) and a **FAULT**, freely addressable to any relay output.

- **The alarm thresholds can be configured with special mode of operation:**

For use in car parking "**PARKING EN**" (EN 50545-1) or to the workplace, such as exposure limit value **TLV**.

- **Each output (relay) can be configured as follows:**

- **Silenceable:** the output is disabled for the **Silence time**, when **RESET** is carried out and the sensor is above the set threshold. This function can, for example, be used for the outputs connected to audible warning devices.
- **Silence Time:** is the time, adjustable from 0 to 300 seconds, so **Silenceable output** (*e.g. relay connected to a siren*) is disabled when the **RESET** is performed and a sensor is above the set threshold
- **Hysteresis ON:** is the delay, adjustable from 0 to 300 seconds, of the relay, associated with an alarm threshold.
- **Hysteresis OFF:** is the delay, adjustable from 0 to 300 seconds, of the relay to return to normal condition, when it ends the alarm.
- **Time ON:** is adjustable from 0 to 300 seconds. This function can only be used if you want to stop the alarm output after a finite time, even if the sensor remains above the alarm threshold set (*This function cannot be used in conjunction with Hysteresis OFF delay*). For example you can use it to enable devices that cannot be powered down, or to send a pulse to a phone dialer.
- **Memorized:** the relay remains in alarm, even if the sensor returns below the threshold (*this function does not work if the Time ON or into Hysteresis OFF has already been inserted a value other than zero*), to return to normal conditions must be done **RESET**. Serves, for example, to prevent the accidental or unauthorized resetting of a block valve of the gas, without first checking the cause of the alarm.
- **Positive Logic:** the operation of the relay can be set normally activated or in positive logic, therefore, if the relay fails, or is completely out of power, automatically moves into the Alarm position, the NC contact becomes NO.

- **The CE408 have a BUZZER inside:**

The internal **Buzzer** sounds a **Beep** every touch of the keyboard. It can also be set to sound in case of Fault and / or Alarm.

- **The CE408 can store the Events:**

The system can store up to 100 events comprising Alarms, Faults, Power ON, Mains blackout and Resetting, that can be re-called at any time.

- **The CE408 has an SD CARD slot:**

It can be used for future updates of the central unit firmware.

- **The CE408 is protected by 3 LEVELS of PASSWORD:**

The functions of the control panel are accessible up to three password levels, with a code composed of 4 numbers. The levels are for access to functions, used by the respective authorized persons.

**LEVEL 1:** User / User

**LEVEL 2:** The Installer / Maintenance technician

**LEVEL 3:** Manufacturer / the assistance technician.



THE FOLLOWING INSTRUCTIONS DESCRIBES ALL THE CENTRAL SYSTEM SETUP PROCEDURES AS WELL AS THE INSTALLATION PROCEDURES TO BE EXECUTED ONLY BY AUTHORISED AND EXPERIENCED PERSONNEL.

## CE408P INSTALLATION

**WARNING:** The **CE408** is to be installed in an area protected from direct sunlight and rain. Please note that for safety the CE408 is to be installed in safe areas where there are present or can form flammable atmospheres and concentrations exceeding 24 % volume oxygen.

**CLEANING:** To clean the exterior of the enclosure, use a soft damp cloth with water, do not use solvents or abrasive cleaners.

**POSITION:** The **CE408P** should be mounted on the wall using 4 screws and wall plugs ( $\varnothing$  6 mm) or 4 M4 screws and nuts, if the wall is not in masonry. The housing's base must be fixed through the 4 holes, placed at the sides of the base (**Fig.2**). The electrical connections are made all in the housing base.

### Fig 2 – CE408P Dimensions and Template for wall mounting

The cover unlocks (with a coin) by turning 90 ° the 4 buttons located above and below the enclosure. It is opened by pulling and then rotating it up until it rests at the base.

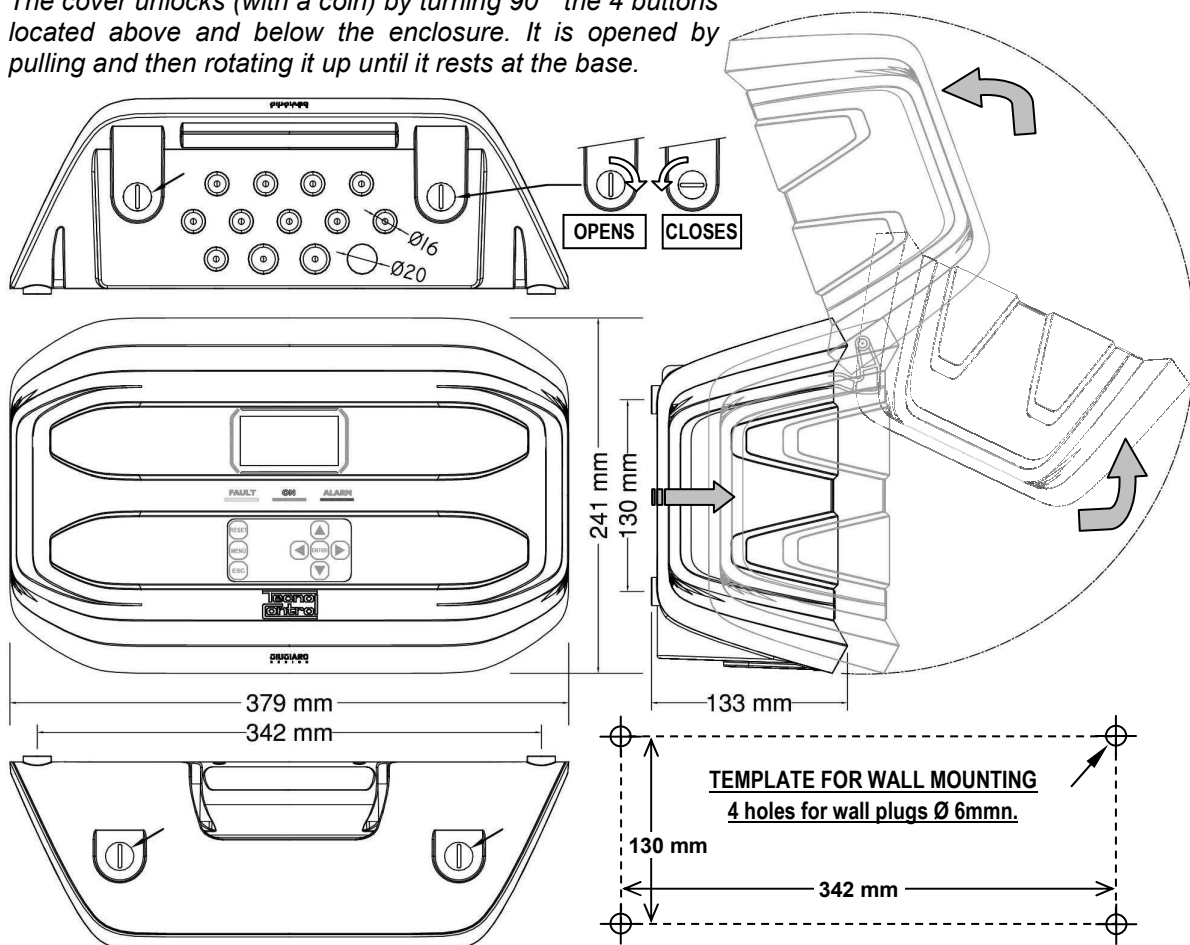

## OPENING-CLOSING THE HOUSING

The housing has two sliding internal hinges. To open the case, you must:

- 1- With a coin or screwdriver (blade 10-12 mm), unlock the 4 closing buttons, turning them 90 ° clockwise.
- 2- Gently, pull the cover outwards of about 4 cm and then rotate it up and place it on the upper edge of the base housing, in this way remain in the open position.
- 3- To close the housing act in reverse order. Pay attention that the cover and the locking mechanism enters into place. Finally block 4 buttons, turning 90 ° counterclockwise. To facilitate the closure, press on the lid, the buttons, which are eccentric, will bring the lid to adhere to the gasket.



## ELECTRICAL CONNECTIONS

The electrical connections should be executed all on the housing base.



The details of the connections to the mains, the two batteries, the AUX input and relay output R9 are illustrated in [Figure 3](#). While the details of the connections to the sensors and the other outputs are illustrated in [Figure 4](#).



The terminals are of "polarized inlet" type (1). We suggest to use lugs adequate to the conductors (2) and to fix the wires to the box structure to avoid excessive stress to the circuits and to the terminals. Use a screwdriver (3) with the right dimensions.

Input terminal,  
plug-polarized

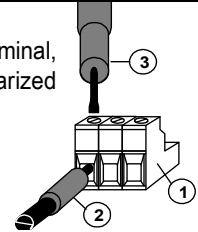

Considering that, it should be normal procedure disconnect power to the electronic equipment when installing, or changing the connections, or when disconnecting or connecting expansion cards.



**IMPORTANT: TO AVOID IRREVERSIBLE DAMAGE, DISCONNECT THE POWER SUPPLY TO THE CONTROL PANEL, MAINS POWER AND BATTERY (IF PRESENTS) DURING INSTALLATIO (WIRING CABLES) OR BEFORE YOU INSTALL ANY EXPANSION BOARDS OR UNPLUG OR RE-CONNECT THE FLAT CABLE.**



Only if necessary, for maintenance or installation requirements, the housing cover can be separated from its base, first remove mains power and remove the batteries, then disconnect the flat cable, press on the two side tabs as shown in [Fig. 3](#). Then you need to release the cover from sliding hinges (press fit). To reconnect it, proceed in reverse order and after hanging up the lid hinges, push the flat cable into the connector, respecting the polarization, the two levers close automatically locking it. Only then you can reconnect power supply.

**BATTERIES:** Inside the housing, it can also accommodate **two 12V/1.3Ah Lead batteries** connected in series ([Fig.3](#)) to assure the system powering in case of mains blackout. The battery life is about 30 minutes with 8 sensors. (The batteries are not included in the delivery, but are available on request).



If required, to increase the autonomy (6 hour), it can be used two 7Ah batteries connected in series, but causes the greatest dimension, shall be installed in a case outside the CE408P.

**Cable glands:** the lower side of the housing has 13 inputs designed for metric cable glands (ISO pitch 1.5 mm). N.10 are for glands M16x1.5 mm (that accept external cables  $\varnothing 4\div 8$  mm) and n.3 are for glands M20x1.5 mm (that accept external cables  $\varnothing 6\div 12$  mm).

These passages are closed, but they are not manually breakable, according to the installation requirements, they must be drilling. To facilitate the operation, they have a centering for the drill bit.

Please, pay attention not touch the tip of the internal circuits or the power supply cables

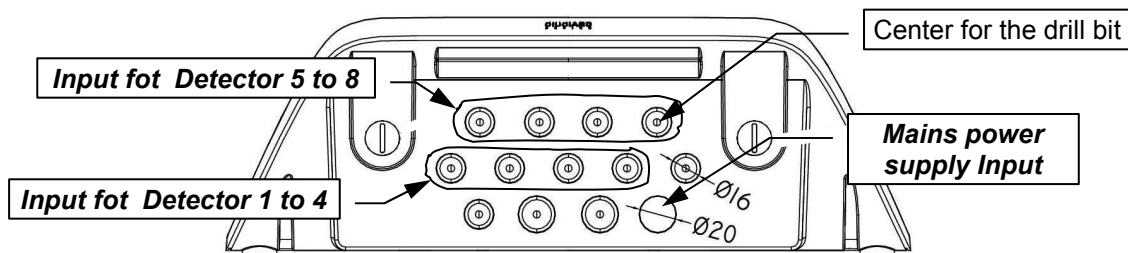

**POWER CONNECTION**

The installation must include a power line protection device. To the mains line, a bipolar disconnecting switch dedicated for the gas detection system. The device, clearly identified, must act only on Phase and Neutral, but not on the Earth. It is advisable to also provide for a surge protector, lightning etc.

Mains Power Supply (90÷264Vdc / 47÷63Hz) should be connected to terminal L, N and Earth at the right of the housing base. The terminal has a protective fuse (5x20) 2A.

The two 12V/1.3Ah Lead batteries if required, should be connected in series to **BAT+** (Red) and **BAT-** (Black) terminals. For the series connection, use the black cable supplied with two terminals (4,8 mm Fastens).

The auxiliary input (AUX) can be used to connect devices with a NO or NC contact (gas sensors with relay contacts, smoke sensors, buttons, etc.). It can be configured to activate one of the available relays. It can be connected to multiple devices if it's are homogeneous. (If the device has an NC contact must be connected in series or in parallel if it's have all a contact NO).

Output Relay 9 has the same characteristics and use of those described on the next page.

**Fig 3 – Wiring diagram for Power, Batteries, AUX input and output 9.**

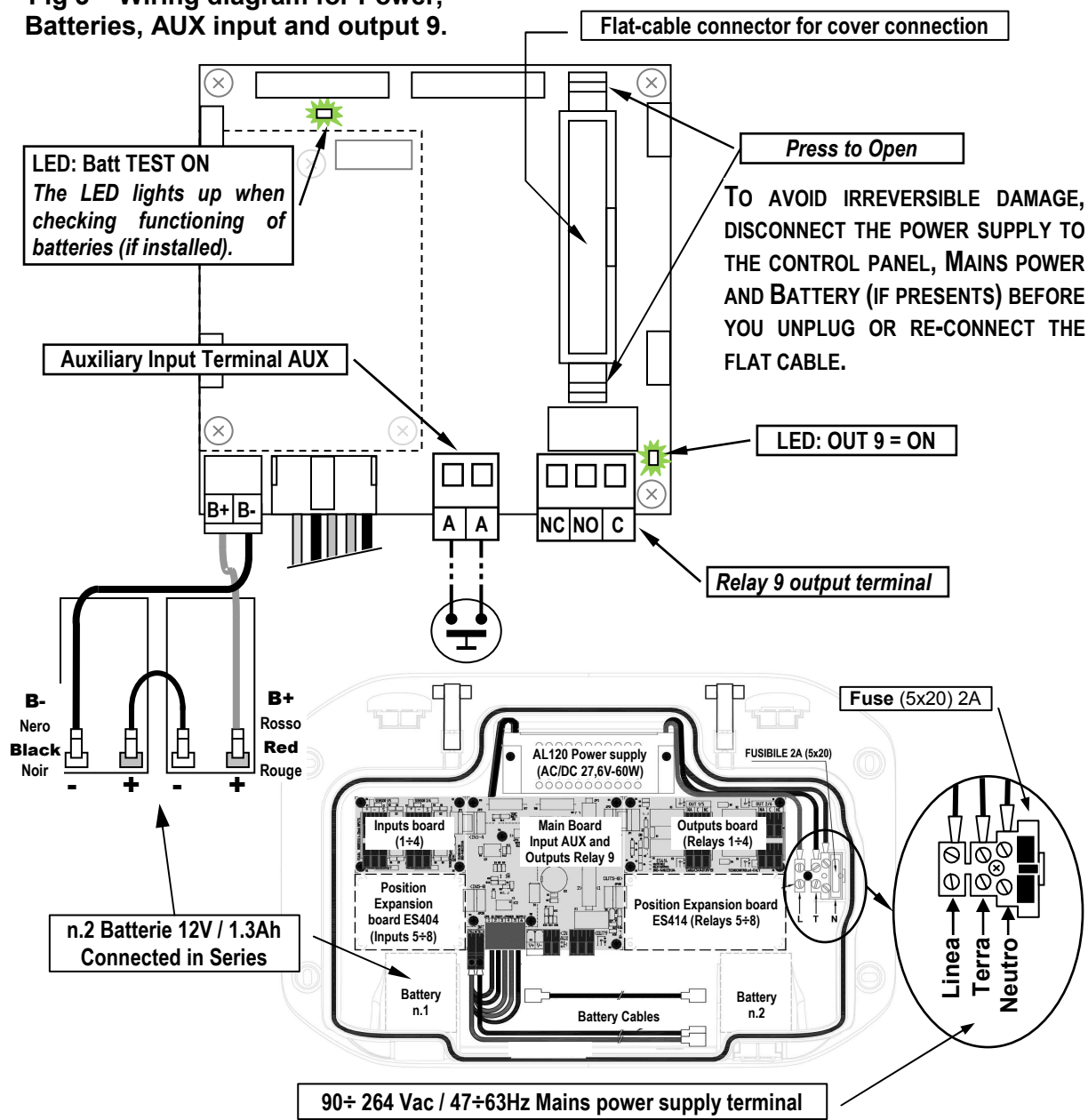

**CONNECTION WITH GAS SENSORS**

 **Please see the specifics User's Manuals of the gas sensors.**

 Please note, that the CE408 has a board with 4 inputs and a board with 4 outputs. In Central can be installed, a board ES404 and ES414 to have a total of 8 inputs and 9 outputs. The diagrams, for simplicity, show all the 8 sensors and all relays outputs.

Sensors connection, with three-wire 4÷20mA transmitters, should be performed on the inputs board, mounted in the base, on the left. The input terminals, "+, - and "S" should be connected to the corresponding terminals of the sensor.

The connection wire section between the CE408 and the sensors should be suitable to the distance, as shown in the table. The connection needs a shielded cable (Cables for control and signaling with shielding copper braid). Shield should be connected only to the central unit side, and on an only point of EARTH that has to be equipotential.

Distance	Cable
Max 200 meters	3 x1 mm <sup>2</sup> shielded
Max 400 metri	3 x 1.5 mm <sup>2</sup> shielded
Max 600 metri	3 X 2.5 mm <sup>2</sup> shielded

The outputs connection, (**Relays**) should be performed on the outputs board, mounted in the base, on the right. *The relay output 9 is located on the central board, see Figure 3.* The nominal load of relay is 250 VAC - 2 A or 30 VDC - 2 A (resistive load).

The relay have changeover free voltage contacts, on the boards, indications **NA means NO** (Normally Open), **NC** (Normally Closed), **C** (Common), refer to the relays in the normal position (not powered). If an output is configured as **POSITIVE LOGIC**, the NO contact will become NC and NC will become NA.

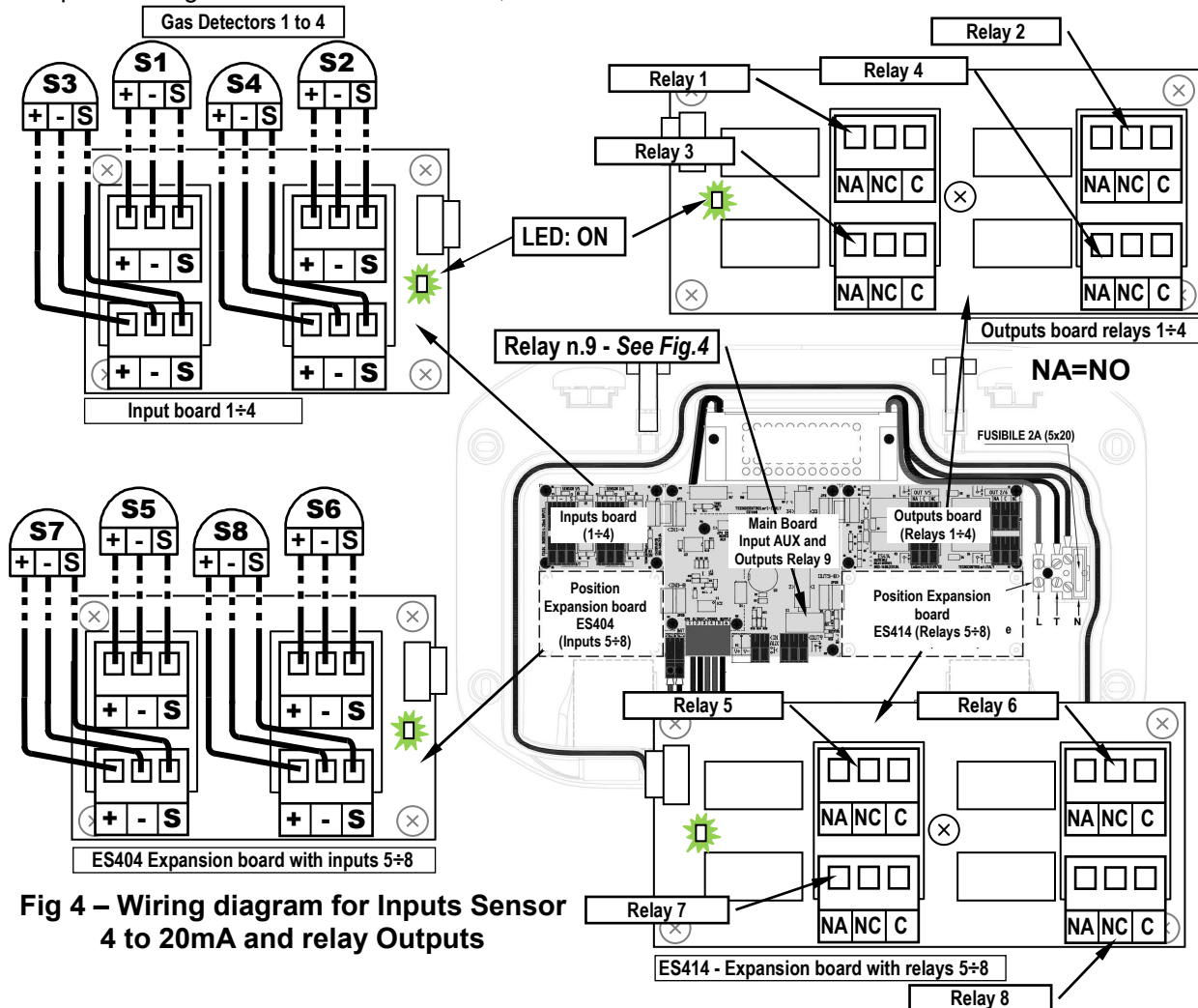

**Fig 4 – Wiring diagram for Inputs Sensor 4 to 20mA and relay Outputs**

## UNIT'S OPERATION

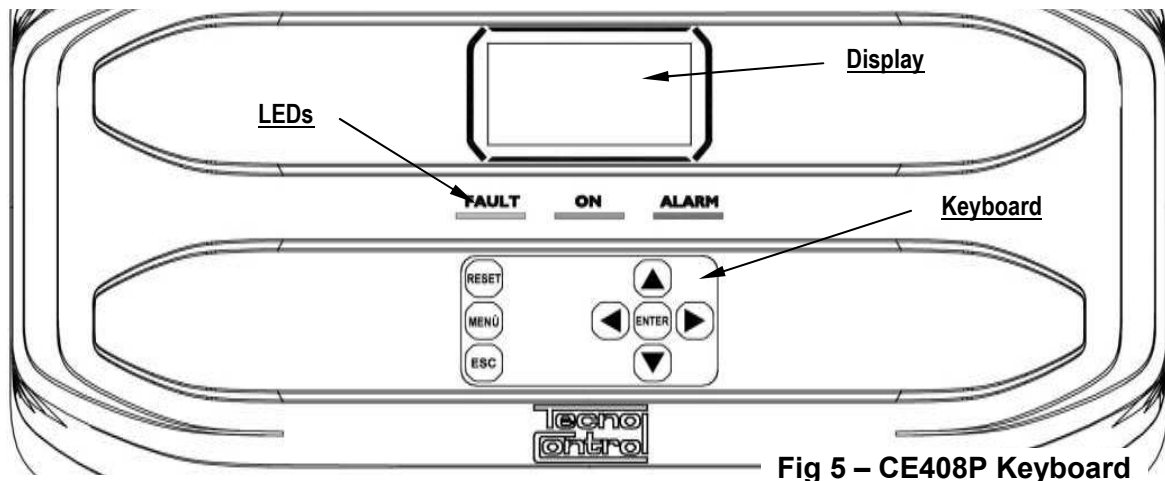







Fig 5 – CE408P Keyboard

### Keyboard:

The keyboard is backlit. To save energy, the brightness is reduced to half after 10 seconds of non-use.

	<b>Can only be used on the main screen</b> , it is used to reset the latched outputs to normal operation, but only if the Sensor or Zone or Input has returned from the alarm condition. If there are active alarms, outputs configured as <b>Silenceable</b> (e.g. alarm) returns to normal operating conditions only for the time of <b>silencing</b> by default.
	Scroll through the display screens and the numeric digits up and down. Keeping the key pressed, increases the values' speed scrolling. In the <b>main screen</b> changes to display the status of sensors, inputs and configured zones.
	Call up the <b>Main Menu</b> from any screen.
	Confirm the inserted data and in the <b>main screen</b> allows you to select the detail's sensors
	Scroll through the pages (6 sensors at a time and 7 events at a time), and input fields. Keeping the key pressed, increases the speed scrolling.
	Cancel an operation and in the <b>main screen</b> is used to enter to <b>Main Menu</b> .

### LED indications

The **CE408P** has 3 LEDs, which show the status of unit operation ([see also Appendix](#)).

<b>FAULT</b> (Yellow LED)	Flashing = Preheat (Start Unit) or Firmware Update.
	Fixed ON = Fault (Sensor) + Buzzer if enabled.
	Short flashing = Output relay associated with a latched Fault. Rapid flashing = Batteries Fault.
<b>ON</b> (Green LED)	Fixed ON = Operation with mains power.
	Flashing = Operation with the batteries.
<b>ALARM</b> (Red LED)	Fixed ON = Alarm 3 is active (Sensor or Zone) + Buzzer if enabled.
	Flashing = Alarm 1 and / or 2 active (sensor or area or logic input).
	Short flashing = alarm latched (indented) (sensor or area or logic input).

### Internal Buzzer Indications

The **CE408** has an internal buzzer that emits a **beep** when a key is pressed. It can also be configured to sound in the event of a fault and / or an alarm.

<b>Sound short (0.1s)</b>	<b>is always active</b>	Confirms the pressing of a key
<b>Continuous sound</b>	<b>if configured</b>	Fault (Sensor or Zone)
<b>Continuous sound</b>	<b>if configured</b>	Alarm 3 is active (Sensor or Zone)

**Display – Initial Screens**

The **CE408P** when powered, for 5 seconds shows the model name and firmware version.----->



*This information shall be accessible also in the menu **Settings**→**General**→**Info**. For more information read the chapter [Settings](#).*



**Only at first power (and only then)** will be asked to choose your language and to indicate if the battery is present. Use the key and to scroll through the languages and pressing the key to confirm the choice. ----->  
From this screen, you cannot go out without being made a choice.

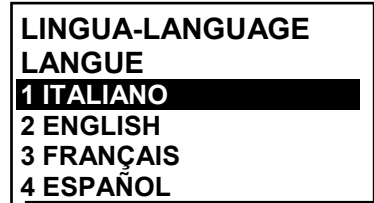

*If necessary, these choices can be changed. Please see forward **Service**→**Battery**. For more information read the chapter [Service](#).*

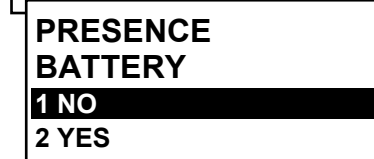

After starts a decreasing count of 60 seconds, the time required to boot the central unit, and allow the sensor to stabilize (**preheating time**). ---->

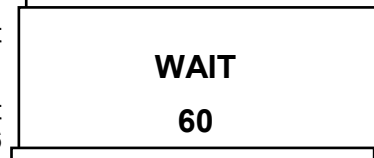

After the preheating time, appears the **Main screen** that the control unit displays in normal operation. The date is shown in the top row, the first 6 sensors (*with the measured concentration and its state*) and in the last line, the battery status of charge (*if installed*) and the presence of mains power: ----->

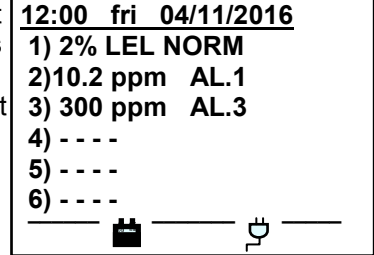

The number in the lower left corner of the display indicates the current access level (level 0 if it is not indicated anything).

**Symbols used to indicate the status of the battery (if installed):**

- = Full charge   = Half charge.   = Low charge
- = Discharge   = Fault.



*If by mistake, the battery (configured present) being disconnected and / or connected with the control unit power from mains, the yellow LED lights up on fast blinking, to resume the normal operation of the battery, it will be necessary turn off and on the unit.*

**Symbols used to indicate the presence of mains power:**

= mains operation (*is absent, when the power is by the batteries*).



*If the control unit, had lost the date and time, due to a malfunction or discharge of the clock backup battery, screen will be displayed for entering updated values (*The unit's safety functions are guaranteed, except those involving the use of date, that will be wrong*). By changing these parameters, see below, the section **SETTINGS**→**DATE and TIME***



**The status of a sensor, which appears on the main screen, may be:**

---	<b>not Configured</b>	The Sensor (detector) is not Configured
***	<b>disable</b>	The Sensor is disabling. (the outputs (relay) are not activated if an alarm occurs)
<b>FAULT</b>	<b>Guasto</b>	input current is less than 1mA
<b>NORM.</b>	<b>Normal</b>	There is no gas and there are no active alarms. The text blinks when relay output is latched ( <i>Sensor or Zone, returned to normality after an alarm or a fault</i> ).
<b>AL.1</b>	<b>Allarm 1</b>	The first alarm threshold has been exceeded
<b>AL.2</b>	<b>Allarm 2</b>	The second alarm threshold has been exceeded
<b>AL.3</b>	<b>Allarm 3</b>	The third alarm threshold has been exceeded.
<b>F.S.</b>	<b>Full Scale</b>	Current > 24 mA. The gas concentration has exceeded the Sensor range or the sensor may be faulty.





When a sensor, a logic input or a zone, activate a relay output, the main screen appears a brief display of alarm status. This allows to check quickly, the total number of active relays and their relative alarm level.

**The details of the individual items is as follows:**

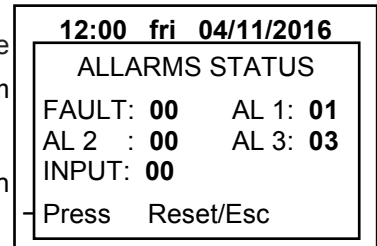
<b>FAULT</b>	Indicates the number of active relays, relative to exceeding the threshold of a fault (current <1 mA or> 24 mA), of a sensor or a group of sensors that belong to a zone.
<b>AL. 1</b>	Indicates the number of active relays, relating to exceeding the threshold of alarm 1, of a sensor or a group of sensors that belong to a zone.
<b>AL. 2</b>	Indicates the number of active relays, related to exceeding the threshold of alarm 2, of a sensor or a group of sensors that belong to a zone.
<b>AL. 3</b>	Indicates the number of active relays, relating to exceeding the alarm threshold 3, of a sensor or a group of sensors that belong to a zone.
<b>INPUT</b>	Indicates the number of active relay, logic input.

The screen can be closed by pressing the  key or the  key. If the alarms persist the screen reappears after 10 minutes. If a new alarm occurs the screen will appear again automatically. ----->





From the **Main screen**, by pressing  and  keys, to scroll through the sensors, in groups of 6 at a time. Pressing  key highlights the sensor in the first row. While, using the keys  and  to scroll through the sensors (in the page) shown on the display.

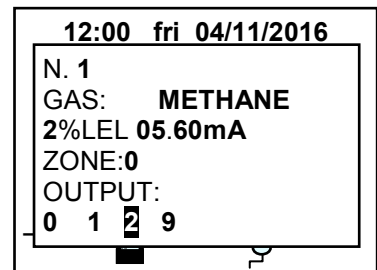

Pressing the key  again, you view the details of the highlighted sensor, (of course only if it is configured). ----->



**Explanations of the details are as follows:**

- 1<sup>st</sup> row** shows the **number** of the sensor
- 2<sup>nd</sup> row** shows the **name of the gas** being measured.
- 3<sup>rd</sup> row** shows the currently measured **gas** concentration, the unit of measure and current value (mA) (*current generated by the sensor*).
- 4<sup>th</sup> row** indicates the **Zone**
  - the indicates the **output** number (Relay), corresponding respectively to:  
**1<sup>st</sup> Threshold (AL1)    2<sup>nd</sup> Threshold (AL2)    3<sup>rd</sup> Threshold (AL3)    FAULT.**
- 6<sup>th</sup> row** **Value 0 (zero)** indicates, at that threshold, the output not been assigned, while the **highlighted value** indicates that output relay is currently active (*alarm*). The values are real time updated.

Pressing the  key it returns to the screen of the sensors. Then press again , to return to the **Main Screen**.

Using the keys  and  is displayed, in cyclic mode, the situation of the Zones (**Z1** and **Z2**) and the Logic Input **AUX (I1)**. ----->

 Note that the model CE408P has only 2 Zone and 1 Logic Input

The status of a logic input can only be **ACTIVE** or **DEACTIVE**, while a Zone has the same status of a sensor, except for the full-scale. ----->

Press  to enter the **Main Menu**.

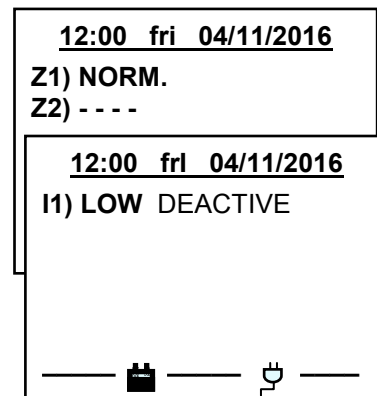

## MAIN MENU



The **CE408** is provided with a main menu from which you can manage all of its functions.

The name of each line indicates the thematic area on which we can take action, by accessing the corresponding submenus.----->

Pressing the key  and  to scroll through the menus.

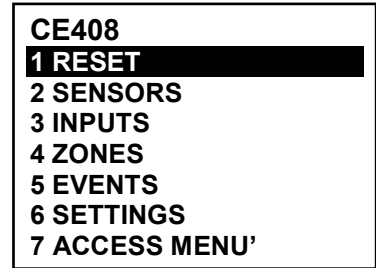
Press  to enter the corresponding submenus.



 Some submenus have an access level (Password) indicated by the symbol "lock" visible when the level was not enabled. To enable it, you must enter the specific password, as shown in [Menu Access](#). Carried out the enabling, the "locks" of the enabled level disappear. 

If you try to enter a submenu without entering the password, the access is denied. A higher access level also enables the lower one.----->

 The required access level is indicated, when necessary, to the left of the individual items of the manual. To enable them, with the password, see the [menu Access](#).

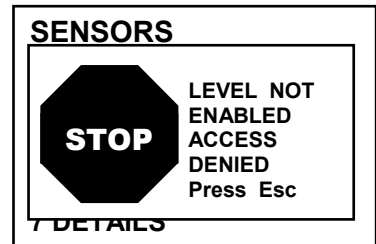

### List and short description of the accessible menus:

<b>1-RESET</b>	Performs silencing or Resetting the alarms and faults, not active and return to the main menu.
<b>2-SENSORS</b>	Enter a submenu where you can <u>enable</u> ①, <u>disable</u> ①, <u>configure</u> ②, <u>modify</u> ②, <u>copy</u> ②, <u>delete</u> ② and view the <u>details</u> of the sensors.
<b>3-INPUTS</b>	Enter a submenu where you can <u>enable</u> ①, <u>disable</u> ①, <u>configure</u> ②, <u>modify</u> ②, <u>copy</u> ②, <u>delete</u> ② and view the <u>details</u> of the logic input.
<b>4-ZONE</b>	Enter a submenu where you can <u>enable</u> ①, <u>disable</u> ①, <u>configure</u> ②, <u>modify</u> ②, <u>delete</u> ② and view the <u>details</u> of the zones
<b>5-EVENTS</b>	Enter a submenu where you can view, <u>all events</u> or ones related only to <u>faults / alarms</u> .
<b>6-SETTINGS</b>	Enter a submenu where you can change, the <u>language</u> ①, <u>general settings</u> , the <u>buzzer settings</u> ① and the <u>date and time</u> ①.
<b>7-ACCESS MENU</b>	Enter a submenu where you can <u>enable</u> , <u>disable</u> , <u>modify</u> , the password, of the relative <u>access levels</u> ① ②.
<b>8-SERVICE</b>	Enter a submenu where you can perform <u>electrical testing</u> ② of the control unit <u>manage the battery</u> ② and display the <u>status of the sensors</u> ②. <u>Start-Up</u> is not accessible.
<b>9-SD CARD</b>	Enter a submenu where you can <u>update</u> ② the Firmware of the control panel via an SD Card. (if inserted)

## RESET

The **RESET** item in the main menu, performs the same function as the  key, reset the latched outputs to normal operation, but only if the Sensor or Zone or Input has returned from the alarm condition.

If there are active alarms, outputs configured as Silenceable (e.g. an alarm) return to normal operating conditions only for the **time of silencing**.

When performing the **RESET** (with key or from the menu), the display shows the confirm message for about 3 seconds, then the previous screen reappears automatically. ----->

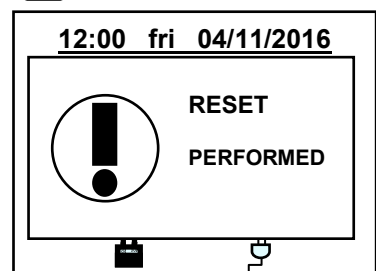

## SENSORS

In this submenu you can manage the sensors connected to the unit. ---->



*The 2-Configure menu, should only be used for a new sensor, to modify the parameters of an already configured sensor only use the 6-Edit menu.*

Below, the individual items are described in detail, with the same level password, which is indicated in parentheses.

**SENSOR**

**1 ENABLE**

**2 DISABLE**

**3 CONFIGURE**

**4 COPY**

**5 DELETE**

**6 MODIFY**

**7 DETAILS**

**ENABLE/DISABLE (Level 1):** These two items allow you to enable or disable one or more sensors, even simultaneously.

The **disabled** sensors, no longer trigger the alarm and fault outputs, associated with them (the outputs remain in a state of normal operation, and then the alarms associated with them are not triggered).

**Disabled** status is displayed on the main screen, next to the sensor, with asterisks "\*\*\*\*\*".

To **enable** or **disable** a sensor press the key on the relevant item, highlighted. With and it is possible to select, if you take action on a single sensor or on a group of sensors. ----->

The first line, is acting on a single sensor. Pressing on the first line, will highlight the number of the sensor. Then with and you choose the desired number and pressing the confirmation window will appear.

The second line, acts on a group of sensors. ----->  
Pressing on the second line, will highlight the first sensor's number of the group.

**ENABLE**

**SENSOR N.**

**FROM N. TO N.**

**ENABLE**

**SENSOR N.**

**FROM N. TO N.**



*You can **enable** or **disable** all sensors, including between two, both from the smallest to the largest number, and the reverse.*

If the two numbers of sensors were equal, the effect is identical to the management of a single sensor.

With and you can choose the number of required sensor, pressing and you change from one value to another and then pressing again confirmation window will appear. ----->

Press to confirm. In case, you want to go back, press . Each time you press this key, you will return to the previous step.

If the sensor or one of the group's sensors is not configured, a window notifies you that the operation is not possible. ----->  
Then the screen returns to the selection of the sensor.

**ENABLE**

**CONFIRM ?**

**YES = ENTER**

**NO = ESC**



*If you have selected a group of sensors, the ones that have been configured are enabled or disable.*

**ENABLE**

**SENSOR**  
**N. 1**  
**NOT CONF.**

If this procedure is correct, a window notifies you that the operation has been successful. ----->

Then the screen returns to the beginning of the management for Enabled or Disable.

**ENABLE**

**SENSOR**

**N. 1**

**ENABLED**



**CONFIGURE (Level 2):** There are two ways to configure a sensor. The first allows you to choose between those **preconfigured sensors**, the second allows a **generic configuration**. ----->

In the first case, you can configure only the models of our production ([see list in Table on Page 35](#)), which have some parameters fixed (*non-editable*) and other editable, all have already been set, including the configuration of the outputs.

In the second case, you can manually enter all the parameters, which are freely editable.

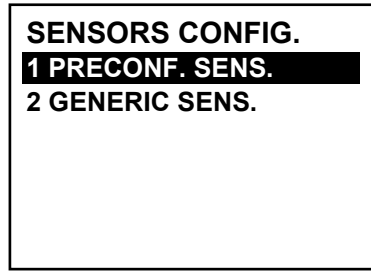

**⚠ For safety, the outputs are configurable only when configuring or changing a sensor, a logic input or a zone. You cannot configure the outputs separately.**

**Configuring PRECONFIGURED SENSOR:** To proceed with the configuration, press **ENTER** on the relevant item highlighted.

Then, using **▲** and **▼** keys and pressing **ENTER** you can choose the sensor's number to be configured. ----->

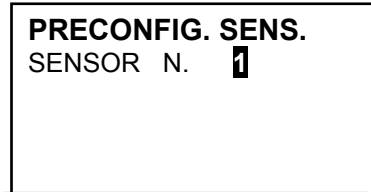

**i** To configure a dual sensor (TS255 series), you must use two consecutive sensors (1-2, 2-3, 3-4, etc.); starting with the first of the two. You cannot start from the sensor n. 8.

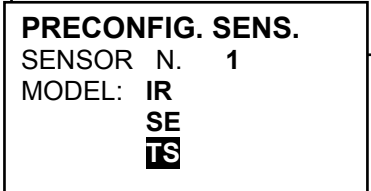

Then you can choose the model number. The code of our products consists of 2 letters followed by 3 numbers, and, if necessary, by other letters (2 to 4). ----->

To choose the desired one, is followed the same structure, must be chosen before the first two letters, then 3 numbers and then the other letters (*if present*).

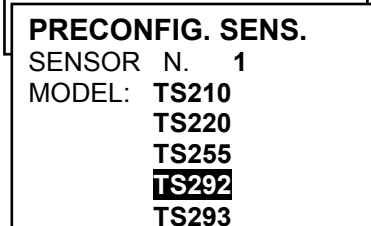

With **▲** and **▼** you can scroll between the groups of letters and numbers that make up the model, with **ENTER** you can confirm your choice and move on. With **ESC** you can go back.

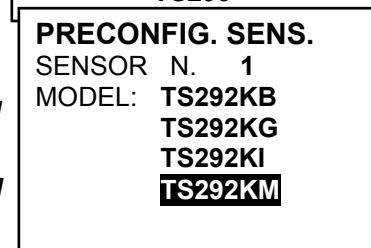

**Example:** for model **TS292KM**, first select **TS** and confirm by pressing **ENTER**. Then select the second item **TS292** and confirm with **ENTER** key. Finally complete the selection by selecting the complete entry **TS292KM** and confirm with.

After choosing the model, its configuration is automatically loaded. ----->

To scroll through the different items, use **▲** and **▼** keys. Pressing **ENTER** on the item, the value is highlighted to indicate that it is editable.

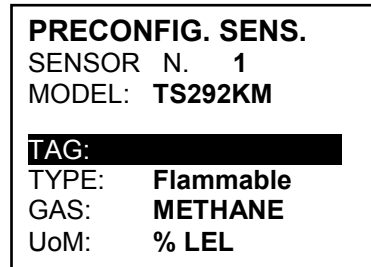

Use **▲** and **▼** to change the value, using **◀** and **▶** you change from to another field in the same row (*where applicable*).

Then pressing **ENTER** the change will be accepted. Pressing **ESC** will restores the previous value and the entire row is selected, indicating that you can only scroll through the items.

**Description of items related to the Preconfigured sensor:**

<b>TAG</b>	It is a <b>TAG</b> than 10 characters, selectable one at a time, where you can write a note or a reminder for a sensor (e.g. FLOOR 2, BOILER, etc.).
<b>AL.</b>	Defines the type of <b>ALARM</b> of the sensor and establishes how they should be set the thresholds of the various alarm levels. In the specific: <ul style="list-style-type: none"> <li>• <b>INCREASING:</b> The alarm levels will be set in ascending order, i.e. <b>SENSOR SCALE ≥ ALARM 3 ≥ ALARM 2 ≥ ALARM 1 ≥ FAULT (current &lt;1mA)</b>. All our sensors, except Oxygen detectors, are set with this type of alarm.</li> <li>• <b>DECREASING:</b> The alarm levels must be set in descending order, i.e. <b>FAULT (current &lt;1mA) ≤ ALARM 3 ≤ ALARM 2 ≤ ALARM 1 ≤ SENSOR SCALE</b>. Only our Oxygen detectors are set with this type of alarm.</li> <li>• <b>OXYGEN:</b> The alarm levels should be set to detect deficiency or excess of the normal presence of oxygen in the air (20.9% v / v), i.e. <b>FAULT (current &lt;1mA) ≤ ALARM 2 ≤ ALARM 1 ≤ 20.5% volume and 21.5% volume ≤ ALARM 3 ≤ SENSOR SCALE</b>. Our Oxygen detectors can be set with this type of alarm.</li> </ul>



Only for Oxygen detectors, Alarm 2 is displayed as AL↓, while the alarm 3 as AL↑

- **TLV:** (*Threshold Limit Values*) are the exposure limit values for toxic substances to which workers may be exposed every day for the entire duration of working life without harmful effects. Must be set in ascending, i.e. **SENSOR SCALE ≥ ALARM 3 ≥ ALARM 1 ≥ ALARM 2 ≥ FAULT (current <1 mA)**. In this case, each alarm level is a value obtained with a temporal average. TLVs in detail are:
  - **ALARM 1 = TLV-TWA** (Time-Weighted Average) is the *time-weighted average concentration* for a conventional 8-hour workday and a 40-hour workweek, to which it is believed that nearly all workers may be repeatedly exposed, day after day, without adverse effect. This alarm is triggered when the weighted average concentration within 8 hours exceeds the set threshold.
  - **ALARM 2 = TLV-STEL** (Threshold Limit Value–Short-Term Exposure Limit) is the concentration to which it is believed that workers can be *exposed continuously for a short period* of time without suffering from irritation, chronic or irreversible tissue damage, or narcosis. STEL is defined as a 15-minute TWA exposure, which should not be exceeded at any time during a workday. This alarm is triggered when the weighted average concentration in the last 15 minutes, exceeds the set threshold.
  - **ALARM 3 = TLV-C** (Threshold Limit Value-Ceiling) is the concentration that *should not be exceeded* during any part of the working exposure. This type of alarm is triggered when the instantaneous concentration exceeds the set threshold. Are not carried out, time weighted average.



Only our sensors for detection of toxic gases can be set up with this type of alarm.

- **PARKING EN:** The alarm levels should be set so increasing, i.e. **SENSOR SCALE ≥ ALARM 3 ≥ ALARM 2 ≥ ALARM 1 ≥ FAULT (current <1 mA)**. In this case, the first two levels of alarm representing a value obtained with a time average between 5 and 60 min. (according to standard EN 50545-1 for the car parks). This value can be set via the parameter **TWA**. Level 3, however is instantaneous.



This type of alarm ([see Table 3](#)) can only be set with our sensors for toxic gases in car parks car (series TS220 and TS293 / EC/EN/EN2) or the dual sensors (series TS255).

- **ZONE:** Sets the area that will be associated with the sensor. The areas available are 2. The area 0 means that the sensor is not associated in any area
- **TWA:** This parameter can only be changed in the sensors where the alarm is **PARKING EN** (in all other cases is fixed at zero). Is how many minutes are carried out time-weighted average for the activation of the 2 alarms? The value can be chosen between 5 and 60 min. (in accordance with standard EN50545-1 for the car parks).
- **THRESHOLD:** Indicates the value, above which, the corresponding alarm is activated.



The thresholds have a hysteresis to prevent the output will cycle on and off continuously (concentration fluctuates around the threshold value). This hysteresis is 20% of the value of the set threshold, for all models of sensors. Only exception is for models for detection of oxygen (TS220EO/TS293EO/TS593EO) whose hysteresis is 2%. The level of fault (FAULT) has a hysteresis of 1mA, so a sensor failure comes out when his current exceeds 2mA.

**Description of the items relating to the outputs:**

**OUTPUT N.** Indicates the number of the output (*relay*). The configurable outputs ranging from 1-9. The output of **0** indicates that there is no output associated with that alarm level.

**If the output boards are not properly connected or mounted, for safety, the corresponding outputs cannot be configured.**



- If the board ES414 is not connected to the terminal **OUT 1-4** outputs will only be available from 5 to 9.
  - If the board ES414 is not connected to the terminal **OUT 5-8** outputs will only be available from 1 to 4 and 9.
  - If it was not connected any board ES414, the only output available is 9.
- The outputs have to configure in a unique way. So, if you were choosing the same output for different alarm levels will be considered valid, only the configuration of the higher alarm. You cannot choose the same output for a level of alarm and fault

**SILENCEABLE** Indicates that the output is disabled, the **Silence time**, when **RESET** is performed. This function can be used for the outputs connected to audible warning devices

**SILENCE T.** Indicates the **Silence time** (adjustable from 0 to 300 seconds), so Silenceable output is cancelled by **RESET**.

**DELAY ON** is the relay delay (Adjustable from 0 to 300 seconds) associated with an alarm threshold.



If the alarm type was selected as **PARKING EN** and you were programming the output on the threshold 3, this delay can only be set from 60 to 300 seconds

**DELAY OFF** The first item **DELAY OFF** (adjustable from 0 to 300 seconds), is the relay's delay, to return to normal status, when it ends the alarm condition.

**TIME ON** The second item, **TIME ON** (adjustable from 0 to 300 seconds) can only be used to stop the alarm output after a preset time, even if the sensor remains above the alarm threshold set. (It can be used to activate devices that cannot be powered on or to send a pulse to a phone-dialer).





The two functions **HISTER.OFF** and **TIME ON**, cannot be used together, or with the **SAVE** function. For safety, if the delay is set other than zero, the parameter stores will be automatically changed to **NO**.

**POS.LOGIC** setting it to **YES**, indicates that the output operation is in **POSITIVE LOGIC** or the relay is normally activated, so, in case of failure automatically moves into the position of the alarm, and then the NC contact becomes NO.

**LATCHED** setting it to **YES**, indicates that the relay remains in alarm, even if the sensor back below the alarm set. To bring it back into the normal, **RESET** must be performer.



The function **LATCHED**, cannot be used simultaneously with **DELAY OFF** or **TIME ON**. For safety, if the parameter **LATCHED**, was set **YES**, the parameters **DELAY OFF** and **TIME ON**, will be automatically set to Zero

At the end of the screen is written **SAVE** to save the configuration entered. Pressing  the confirmation window will appear. Press again  to confirm, or press  to go back and make changes.



Only for double sensors, TS255 series, at the end of the screen, the message **CONTINUE** appears. Because in this case, must be programmed two consecutive sensors. Only after the second configuration, you can save the configuration entered.

If the set thresholds were in contrast with the criteria for this type of alarm set, or if it had selected the same output for one of the alarm levels and the Fault, a warning message will appear. ----->

Then the screen returns to the configuration of the sensor



**PRECONFIG. SENS.**

**ERROR  
CONFIGURATION  
CONTROL  
PARAMETERS**

If this procedure is correct, a window notifies you that the operation has been successful. ----->

Then the screen returns to the selection of the type of configuration.

**Configuring a GENERIC SENSOR:** to proceed with the configuration, press  on its line.

Then, in the corresponding screen, with  and  key and pressing  you can choose the number of the sensor to be configured. ----->

Then the model is set as **GENERIC** and it is possible, move on to setting of all parameters.

**The parameters should be inserted similarly to the configuration of the Preconfigured Sensor. In this case, however, you can also change the following items:**

#### PRECONFIG. SENS.





SENSOR  
N. 1  
CONFIGURED

#### GENERIC SENSOR

SENSOR N. **1**

#### Description of the items relating to the Generic Sensor:

<b>TYPE</b>	It indicates the gas that the sensor will detect. You can choose between <u>Flammab.</u> (Flammable), <u>Toxic</u> , <u>Vital</u> (e.g. Oxygen), <u>Asphixian.</u> (e.g. CO <sub>2</sub> is asphyxiating) and <u>Refriger.</u> (Refrigerant e.g. R134a).
<b>GAS</b>	It indicates the name of the gas for which the sensor has been calibrated. You can choose between METHANE, LPG, PETROL ( <i>Petrol vapours</i> ), HYDROGEN, VARIOUS ( <i>various gases</i> ), STYRENE, ACETYLENE, AMMONIA, CO, CO <sub>2</sub> , H <sub>2</sub> S, NO, NO <sub>2</sub> , SO <sub>2</sub> , HCN, OXYGEN, CL <sub>2</sub> e HCL.
<b>UoM</b>	It indicates the <b>unit of measurement</b> of the concentration detected by the sensor. You can choose between <u>%LEL</u> (Lower Explosive Limit), <u>%vol</u> (Volume), <u>ppm</u> (parts per million), <u>ppb</u> (parts per billion) and <u>°C</u> (temperature in degrees Celsius).
<b>RANGE</b>	It shows the sensor's <b>full scale</b> . It consists of four digits and you can also set the decimal point. The numbers allowed, ranging from a minimum of <b>1</b> , <b>0.1</b> or <b>0.01</b> up to a maximum of <b>9999</b> , <b>99.9</b> or <b>9.99</b> . Other values or combinations are not accepted and, if entered, will display the previous value

With the  and  you can move from one digit to another, while with  e  you can change the value.









The configurations of the full scale that use a number of digits less than 4 must be preceded by a **space**

**Example:** To obtain a Range of 90 to enter **space, space, 9, 0**. Instead, the values **space, 9, 0, space** or **9, 0, space, space**, will not be accepted.



**COPY (Level 2):** This item allows you to copy the configuration of a sensor to another sensor or group of sensors.

To copy a sensor, press  on its item.

Then you enter the screen where pressing  and using  and  keys, you can choose which sensor to copy. ----->

After pressing  again to confirm, you can use the  and  key, choose whether to copy on a single sensor or in a group. ----->

The first line acts on a single sensor. Pressing  on the first line, will be highlighted the number of the sensor.

Then press  and  keys, to select the desired number, then press  will appear the confirmation window.

#### COPY

SENSOR N. **1**

#### COPY

SENSOR N. **1**

**ON SENSOR N.**

FROM N. TO N.

The second line, acts on a group of sensors. Pressing **ENTER** on the second line will be highlighted the number of the first sensor group. ----->

**i** You can copy all sensors, between 2. Both from the smallest number too largest, or the contrary. If two numbers, of sensor were equal, the effect is equal to the management of the single sensor

With **▲** and **▼**, you choose the number of sensor you want, with the keys **◀** and **▶**, you can go from one extreme to another. Then press **ENTER**, the confirmation window will appear. ----->  
Press **ENTER** to confirm. To go back, press **ESC**. Each time you press it, you will return to the previous step.

If the sensor you want to copy is not configured, a window notifies you that the operation is not possible.----->

Next, the screen returns to the choice of sensor.

If this procedure is correct, a window notifies you that the operation has been successful.----->

Then the screen returns to the beginning of the copy management.

**COPY**

SENSOR N. **1**

ON SENSOR N.

**FROM N. TO N.**

**COPY**

**CONFIRM ?**

YES = ENTER  
NO = ESC

**COPY**

**STOP**

SENSOR N. 1  
NOT CONF.

**COPY**

SENSOR N. 1  
COPIED  
FROM N. 2 TO N. 4

**DELETE (Level 2):** This item allows you to delete the configuration of a sensor or a group of sensors.

To delete a sensor, press **ENTER** on the relevant item.

Using **▲** and **▼** keys, you can choose which sensor or group to delete. ----->

The first line acts on a single sensor. Pressing **ENTER** on the first line, will be highlighted the number of the sensor.

With **▲** and **▼**, you choose the number of sensor you want, then press **ENTER** will appear the confirmation window.

The second line acts on a group of sensors.----->

Pressing **ENTER** on the second line, will be highlighted the 1<sup>st</sup> sensor number of the group.

**i** You can delete all sensors, between 2. Both from the smallest number too largest, or the contrary. If two numbers, of sensor were equal, the effect is equal to the management of the single sensor

With **▲** and **▼**, you choose the number of sensor you want, with the **◀** and **▶** keys, you can go from one extreme to another. Then press **ENTER**, the confirmation window will appear. ----->

**DELETE**

**SENSOR N.**

**FROM N. TO N.**

**DELETE**

SENSOR N.

**FROM N. TO N.**

**DELETE**

**CONFIRM ?**

YES = ENTER  
NO = ESC

Press **ENTER** to confirm. To go back, press **ESC**. Each time you press it, you will return to the previous step.

After confirmation, the window will notify that the operation has been successful.----->

Then the screen returns the beginning of the management the deletion.

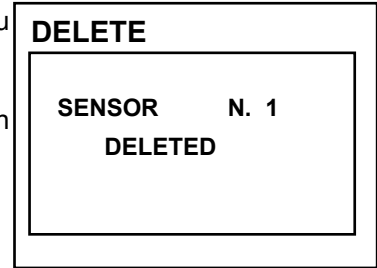

**MODIFY (Level 2):** This item allows modifying a sensor already configured.

To modify a sensor press **ENTER** on its entry.

The parameters are modified and saved similarly to the configuration Preconfigured, but in this case, it is not possible to change the following items: **MODEL, TYPE, GAS, UoM, RANGE, AL.**

**DETAILS:** This item allows you to see parameters of a sensor configured.

To see the details of a sensor, press **ENTER** on its entry. In case you want to go back, press **ESC**.

Choosing the sensor, the voices are the same as the configuration of a sensor Preconfigured. You can scroll through them using **▲** and **▼**.

Then at the end of the screen, is also referred to the enable status of the sensor.

Finally, selecting the row containing the number, if it is different from zero, you can press **ENTER** to view its details.----->

The items of the details can be scrolled with **▲** and **▼** keys. In addition, at the end of the screen, displays the status of silencing output.

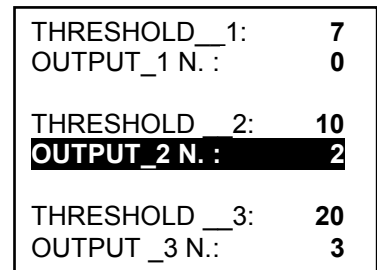

## LOGIC INPUT

In this submenu is possible to manage the logic input connected to the unit.----->

**ENABLE/DISABLE (Level 1):** These two items allow you to **enable** or **disable** the only one **Logic input**. The status **Disabled** is displayed on the main screen, next to Input, the symbol "\*\*\*\*\*".

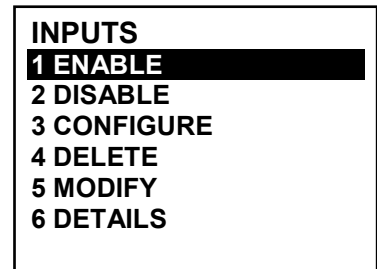

 *The input **disabled**, do not activate the relay output associated with it. The output remains in a state of normal operation and therefore the devices attached to them are not triggered*

To **enable** or **disable** the Logic Input, press **ENTER** on the highlighted item.

Press **ENTER** to confirm.----->

Then the confirmation window will appear----->

Press **ENTER** to confirm or to go back, press **ESC**.

If the Logic Input were not been configured, a window notifies you that the operation is not possible e then the screen returns to the selection of Input.----->

If this procedure is correct, a window notifies you that the operation has been successful.----->

Then the screen returns the beginning of the management the Enable or Disable.

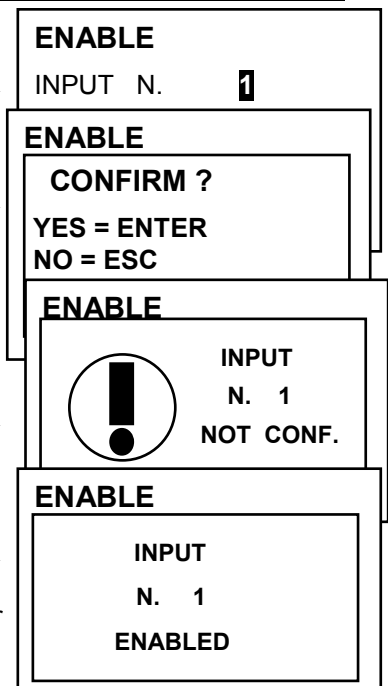







**CONFIGURE (Level 2):** Press **ENTER** on the item to configure the Logic Input.

 For safety, the outputs are configurable only in configuration or modification of a Sensor, a Logic Input or a Zone. You cannot configure the outputs separately.

Press **ENTER** to configure the Logic Input.----->

 It is recalled that the central CE408P, has only one logic input.

Use  and  to scroll through the various items and then pressing **ENTER** is highlighted only the value, indicating that you can change it. ---->

Then use  and  values are changed, while  and  goes from field to field on the same line (where applicable) and then pressing **ENTER** the change is accepted.

While pressing **ESC** restores the previous value and the entire line is highlighted, indicating that you can only scroll through the items. The following explains the various items in detail.

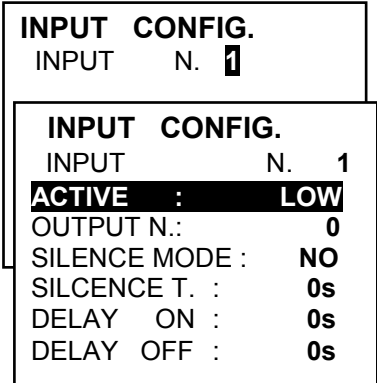

**Description of items relating to Logic Input:**

**ACTIVE** Indicates how we consider, activated the entrance. **LOW** means that it is active when it is short-circuited (e.g. pushbutton). **HIGH** means that it is active when open.

**Description of items relating to Outputs (relays):**

[This description is the same as one written in the chapter CONFIGURE SENSORS. Please see page 16 \(OUTPUT N, SILENCEABLE, SILENCE T., DELAY ON, DELAY OFF/TIME ON, POS.LOGIC, LATCHED\).](#)

At the end of the screen, is written **SAVE**, to save the configuration inserted. Pressing **ENTER** the confirmation window will appear. Press again **ENTER** to confirm. In case you want to go back, press **ESC**.

After having confirmed, a window notifies you that the operation has been successful.----->

Then the screen returns the beginning of the management Configure Logic Inputs.

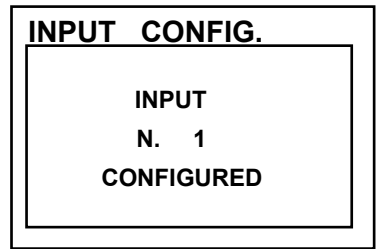

**DELETE (Level 2):** This item allows you to delete the configuration of the **Logic Input**.

To delete the input, press **ENTER** on the relevant item. Then press **ENTER** to confirm.----->

Then the confirmation window will appear.

Press **ENTER** to confirm or to go back, press **ESC**.----->

If this procedure is correct, a window notifies you that the operation has been successful.----->

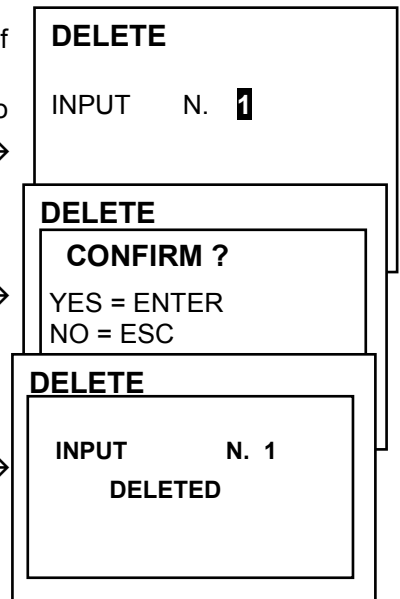

Then the screen returns the beginning of the Delete item management.





**MODIFY (Level 2):** This item allows modifying a Logic input already configured, pressing  on the item. The parameters are modified and saved similarly to the configuration.

**DETAILS:** This item allows you to see parameters of a Logic input already configured, pressing  on its item.

The voices are the same as the configuration of the Logic Input, are shown entries for the input and the number of the corresponding output. In case you want to go back, press .

You can scroll through them using  and . Then at the end of the screen, is also referred to its status, and the enabling status of the Logic Input.

Finally, selecting the row containing the output number, if it is different from zero, you can press  to view its details. ----->

The items of the details can be scrolled with  and  keys. In addition, at the end of the screen, displays the status of silencing output.

INPUT DETAILS	
INPUT	N. 1
ACTIVE	: LOW
<b>OUTPUT N. :</b>	<b>2</b>
STATE	: HIGH
ENABLE	: YES

## ZONES

In this submenu is possible to manage the Zones of the sensors, connected to the unit. ----->

The zones can be used in different ways compatible with the number of available outputs:

**A** - To group more sensors of the same model, and using for all the same outputs (relay) only configured in the area. In the individual sensors can only be configured the alarm thresholds, setting the number of outputs to '0'. In this case when the sensors belonging to the area, exceed the thresholds set, also how has been made the choice of operating logic, will trigger the related relay outputs...

**B** - To group different models of sensors, placed in the same room or on the same floor. In the individual sensors can only be configured the alarm thresholds and relays outputs, and in the area is possible set the relay outputs common to all these sensors.



ZONES	
<b>1</b>	<b>ENABLE</b>
<b>2</b>	<b>DISABLE</b>
<b>3</b>	<b>CONFIGURE</b>
<b>4</b>	<b>DELETE</b>
<b>5</b>	<b>MODIFY</b>
<b>6</b>	<b>DETAILS</b>





**ENABLE/DISABLE (Level 1):** These two items allow you to **enable** or **disable** one or more Zones, even simultaneously.

**Disabled** status is displayed on the main screen, next to the Zone, with asterisks "\*\*\*\*\*".

 The **disabled** Zones, no longer trigger the alarm and fault outputs, associated with them (the outputs remain in a state of normal operation, and then the alarms associated with them are not triggered).

To **enable** or **disable** a zone, press the  key on the relevant item.

With  and  it is possible to select, if you take action on a single zone or on a group of Zones. ----->





The first line, is acting on a single Zone. Pressing  on the first line, will highlight the number of the zone. Then with  and  you choose the desired number and pressing  the confirmation window will appear.



The second line, acts on a group of Zones, pressing  on the second, will highlight the first zone's number of the group. ----->

 You can **enable** or **disable** all Zones, including between two, both from the smallest to the largest number, and the reverse.

ENABLE	
<b>ZONE N.</b>	
FROM N.	TO N.
<b>ENABLE</b>	
<b>ZONE N.</b>	
<b>FROM N.</b>	<b>TO N.</b>



With  and  key, you can choose the number of required Zone, pressing  and  you change from one value to another and then pressing again  confirmation window will appear. ----->

Press  to confirm or in case, you want to go back, press .

If the zone or one of the group's Zones is not configured, a window notifies you that the operation is not possible. ----->

Then the screen returns to the selection of the Zone.



*If you have selected a group of Zone, the ones that have been configured are enabled or disable. Dialog box appears to warn you that you have selected one or more zones are not configured.*



If this procedure is correct, a window notifies you that the operation has been successful. ----->



Then the screen returns to the beginning of the management for Enabled or Disable.







**CONFIGURE (Level 2):** Press  on the item to configure a Zone.



*For safety, the outputs are configurable only when configuring or changing a sensor, a logic input or a zone. You cannot configure the outputs separately.*

Using the  and  keys and pressing  you can choose the Zone's number to be configured. ----->

Then, use the  and  key, to scroll through the different items. Pressing  on the item, the value is highlighted to indicate that it is editable. ----->

Use  and  to change the value, using  and  you change from to another field in the same row (*where applicable*). Then pressing  the change will be accepted. Pressing  will restores the previous value and the entire row is selected, indicating that you can only scroll through the items.

ENABLE

CONFIRM ?

YES = ENTER  
NO = ESC

ENABLE



ZONE  
N. 1  
NOT CONF.

ENABLE

ZONE  
N. 1  
ENABLED

ZONE CONFIG.

ZONE N. 1

ZONE CONFIG.

ZONA N. 1  
**LOGIC : AND**  
OUTPUT\_1\_THRESH\_1  
OUPUT N. : 0  
SILENCE MODE : NO  
SILENCE T. : 0s  
IST.ON : 0s

### Description of items related to the Zone:

**LOGIC** It defines the logical operator to activate of the outputs (*relay*) on the thresholds:

- **AND (logical product):** The outputs relating to thresholds, are triggered only when all the sensors in the area exceeds its threshold.
- **OR (logical sum):** The outputs relating to thresholds are triggered when one or more sensors in the area exceed its threshold. (It is the **normal operation**, each sensor activates the alarms at exceeding of the set threshold).
- **CORR.CON (Correspondent Consecutive):** The outputs relating to thresholds are triggered when two consecutive sensors in the area exceed its threshold. The last and the first are not considered consecutive (e.g. installation along a corridor).
- **CIRC.CON (Circular Consecutive):** The outputs relating to thresholds are triggered when two adjacent sensors in the area exceed its threshold. The last and the first are considered consecutive (e.g. installation in a circle).
- **PARK-ITA (Only for Italy, Parking in accordance with the Italian Ministerial Decree):** The outputs relating to thresholds are triggered when two sensors belonging to the zone exceeds its threshold. This configuration should be used if you have to program the control panel according to **DM 02/01/1986 (point b of paragraph 3.9.3)** valid only in Italy for the car parks.



Please note that the CE408 has two outputs for each level of alarm, and a fault output, for a total of 7 outputs configurable for each zone.

### Description of the items relating to the outputs:

[This description is the same as one written in the chapter CONFIGURE SENSORS. Please see page 16 \(OUTPUT N, SILENCEABLE, SILENCE T., DELAY ON, DELAY OFF/TIME ON, POS.LOGIC, LATCHED\).](#)

At the end of the screen is written **CONTINUE** to proceed in the configuration (in the configurations of outputs relative to threshold 1 and threshold 2). Press again , you can continue until, in the configuration screen of the outputs on the threshold 3, and Fault, there is the message **SAVE**, that allows you to save the configuration entered.

Pressing  the confirmation window will appear. Press again  to confirm, or press  to go back and make changes.

If this procedure is correct, a window notifies you that the operation has been successful. ----->

Then the screen returns to the Zone configuration.

**ZONE CONFIG.**

ZONE  
N. 1  
CONFIGURED

**DELETE (Level 2):** This item allows you to delete a Zone or a group of Zones. To delete a zone press  on the relevant item.



**WARNING:** deleting a zone, relay outputs, configured no longer be available.

Then using  and  key, you can choose which Zone or group to delete. ----->

The first line acts on a single Zone. Pressing  on the first line, will be highlighted the number of the single zone. Then with  and  you choose the number of Zone you want, then press again  will appear the confirmation window.

Pressing  on the second line, will be highlighted the 1<sup>st</sup> zone number of the group. ----->

**DELETE**

ZONE N.

FROM N. TO N.

**DELETE**

ZONE N.

FROM N. TO N.

**i** You can delete all zones, between 2. Both from the smallest number too largest, or the contrary. If two numbers, of zones were equal, the effect is equal to management of a single Zone.

With  and  you choose the number of zone you want. With  and  you can go from one extreme to another. Then pressing  the confirmation window will appear. ----->

**DELETE**

**CONFIRM ?**

YES = ENTER  
NO = ESC

Press  to confirm, or press  to go back. Each time you press it, you will return to the previous step.

After confirmation, the window will notify that the operation has been successful. ----->

Then the screen returns the beginning of the management the deletion.

**DELETE**

ZONE N. 1  
DELETED

**MODIFY (Level 2):** This item allows modifying a Zone already configured. Press  on the item. The parameters are modified and saved in a similar way to the configuration of the Zone.

**DETAILS:** This item allows you to see parameters of a Zone already configured, pressing  on its item.

The voices are the same as the configuration of the Zones, are shown the zones and the number of the corresponding output. In case you want to go back, press **Esc**.

You can scroll through them using **▲** and **▼**. Then at the end of the screen, is also referred to its status, and the enabling status of the Zone.

Finally, selecting the row containing the output number, if it is different from zero, you can press **ENTER**, to view its details. ----->

The items of the details can be scrolled with **▲** and **▼**. In addition, at the end of the screen, displays the status of silencing output.

ZONE DETAILS	
ZONE	N. 1
LOGIC:	AND
OUTPUT 1 THRESH 1	
<b>OUTPUT N. :</b>	<b>2</b>
OUTPU_2_THRESH_1	

## EVENTS

In this submenu is possible to view the last **100** stored events. ----->

**ALARMS/FAULTS:** are only events related to **faults** and **alarms** of the sensors, of the inputs, outputs and related zones. They are sorted from newest to oldest.



*The control unit stores the events in a cyclic manner, i.e., after 100, the oldest event is deleted.*

EVENTS	
<b>1</b>	<b>ALARMS/FAULTS</b>
<b>2</b>	<b>ALL ONES</b>

To view the Events, press **ENTER** on its item. The screen shows the date, time and type of event. The events are displayed in groups of on the same day starting with the most recent.

Events and Days can be scrolled using **▲** and **▼** key.

- **First line:** is the event date, in the format dd / mm / yy (Day / Month / Year).  
**Each subsequent line is an event**
- **First part:** it is the time of the event, in the format hh / mm / ss (Hours / Minutes / Seconds).
- **Second part:** the event type is as follows:
  - **First letter:** indicates the object to which the event refers:
    - 'S': Sensor.
    - 'I': Logic Input.
    - 'Z': Zone.
    - 'O': Output (relay).
  - **Two numbers:** Is the number of the object to which the event refers.
  - **Status:** This is the new state reached by the object that caused the event. Specifically:
    - The Logic Inputs can have 2 states: **ACT.** (Active) or **DEA.** (Deactive).
    - Outputs (relay) can have 3 states: **ACT.** (Active), **DEA.** (Deactive), **SIL.** (Silenced).
    - Sensors and Zones can have 6 states: **FLT** (Fault), **NORM** (Normal), **AL1** (Alarm 1), **AL2** (Alarm 2), **AL3** (Alarm3), **OVS↑** (Over scale).

**Example:** in the screen, on the left.

The **first line** indicates that you are seeing the events of 04 November 2016. ----->

The **second line** indicates that, at 15 hours, 12 minutes and 3 seconds (15:12:03) the sensor no.2 (S 02) exceeded the 1<sup>st</sup> alarm threshold (AL1).

The **third line** indicates that at 14 hours, 45 minutes and 21 seconds (14:45:21), the output relay no.5 (U 05) has been activated (ACT.).

The **fourth line** indicates that at 10 hours, 38 minutes and 57 seconds (10:38:57) the Logic Input no.1 (I 01) has been deactivated (DEA).

In the **other rows**, there are no events.

EVENTS	04/11/16
15:12:03	S 02 AL1
14:45:21	U 05 ACT.
10:38:57	I 01 DEA.
NO	EVENT
NO	EVENT
NO	EVENT
NO	EVENT

**ALL:** are the all events, stored in the unit, sorted from newest to oldest, faults and alarms (*sensors, inputs, outputs and related zones*) and generic (*presence or absence of mains power, control panel power on, and the reset*).

To access this viewing, press **ENTER** on the relevant item. Using **◀** and **▶** you can scroll through the events, which are displayed and sorted in the same way described above for the submenu **ALARM / FAULT**.

In addition to the above matters are those of the generic event that, after the hour, they can show the following details:



- **POWER ON:** Indicates that the control panel has been switched on.
- **MAIN YES:** Indicates that the unit is powered from the mains (*if the batteries are installed*).
- **MAIN NOT:** Indicates that the unit is powered by batteries (*only if batteries are installed*).
- **RESET:** Indicates that has been executed, the Reset command.

## SETTINGS



In this sub menu, you can manage some settings of the unit. ----->

**LANGUAGE (Level 1):** To change the language of the unit, press

 on the relevant item.

Using  and  choosing from the list, the one you want, then press

 will appear the confirmation window. ----->

Press again  to confirm, or to go back, press .

A window notifies you that the operation has been successful. ----->

Then the screen returns to the beginning of the Settings management.

### SETTINGS



- 1 LANGUAGE
- 2 GENERALS
- 3 BUZZER
- 4 DATEandTIME

### LANGUAGE

- 1 ITALIAN
- 2 ENGLISH
- 3 FRENCH
- 4 ESPAÑOL



### LANGUAGE

SETTINGS  
SAVED



**GENERALS:** Pressing  on this item, you can edit or view other settings of the control panel. Using  and  you choose which item change or view.

• **CONTRAST:** Adjusts the display contrast. Press  and then adjust the value using  and  key. ----->

Reached the desired value, press  the confirmation window will



appear. If you wish to go back, press  otherwise press  again to confirm. A window will prompt you that the operation was successful. Then the screen returns the beginning of manage Settings.

- **INFO:** Displays for 5 seconds, the information about the central unit: model, firmware version, and contacts for service. ----->

**BUZZER (Level 1):** you can handle activate the internal buzzer, if there is a fault or alarm of a sensor, or a zone, press  on this item, then using  and  key, you can choose which item to edit.

- **ALARMS:** When set to **YES**, the internal buzzer will be activated if a sensor or a zone goes into Alarm condition.
- **FAULTS:** When set to **YES**, the internal buzzer will be activated if a sensor or a zone goes into fault condition.

Press  and using  and  key, to modify these parameters --->

After choosing the desired value, pressing  the confirmation window will appear. Then press  to confirm or to go back, press .

A window will prompt you that the operation was successful. Then the screen returns the beginning of manage Settings.

### GENERALS





- 1 CONTRAST 15
- 2 INFO



### CE408

Ver. 1.0X  
TECNOCNTRONL srl  
Via Miglioli, 47  
20090 Segrate (MI)  
ITALY  
Tel +39 02 26922890  
info@tecnocntroni.it

### BUZZER

ALLARMS: **NO**  
FAULTS: NO

**DATE and TIME (Level 1):** To change the date and time, press  on its item. With  and  values can be modify, using  and  you can go from one value to another. ----->

Then move on the **SAVE** and press . Confirmation window will appear. In case you want to go back, press  or press  to confirm.

The window will inform you that the operation was successful. Then the screen returns the beginning of manage Settings. If it had been inserted, an incorrect date (i.e.: 30/02 / ...) window will warn you of the error. ----->

Then the screen returns the beginning of manage Date and Time.

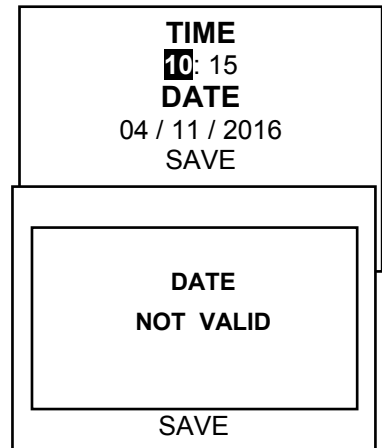

 The central unit has an internal battery that powers the clock when the unit is turned off. If date and time are required on power, the backup battery may be discharge and / or faulty, please contact our customer service for replacement.

## ACCESS MENU

In this submenu, you can manage the passwords, for access to the protected menus. Press  or the related numeric key ----->



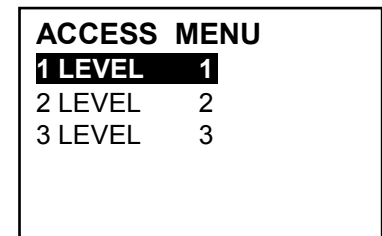

**The PASSWORD Level 1 and Level 2  
Are factory-set to 0000.**

 Please note that the accessible levels are only the first two:  
**LEVEL 1:** for the User  
**LEVEL 2:** for the installer or Maintenance technician  
**LEVEL 3:** is reserved only to the Manufacturer (Tecnocontrol).



**ENABLE LEVEL:** This item allows you to **enable** the relative access level.

Press  on its item. ----->

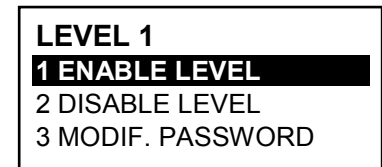

With the numeric keys or  and  key, you can enter the value, with  and  you move from one number to another. ----->

After entering the password, move to **OK** and press .



If the password is correct, the window will confirm you that the operation has been successful. ----->

Then the screen returns the beginning of managing access to menus.

 Enabling an access code on the display at the bottom left, shows the number of its access level. In addition, the "locks"  of the level enabled, disappears.

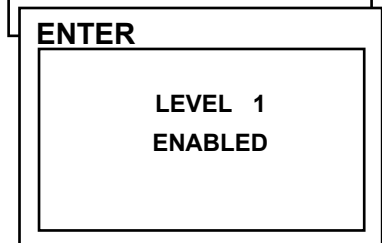
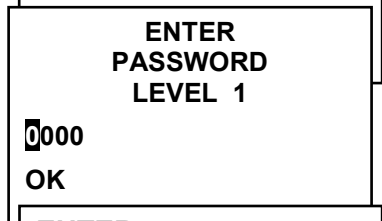



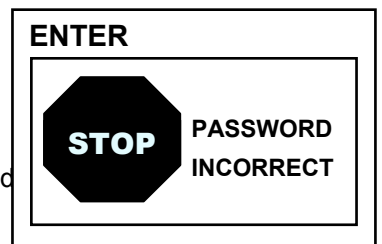

 For safety, after 1 hour, all passwords are restored.

If an incorrect password was entered, the window alert you of the error and return to the screen for entering the password. ----->



**DISABLE LEVEL:** This item allows you to **disable** the relative access level.

 *By performing the disabled, are disabled also all higher levels (e.g. disabling level 1, are disabled, the levels 2 and 3).*

Press  on its item. Then will appear the confirmation window. Press  to confirm, or to go back, press .

Then a window notifies you that the operation has been successful. ----->  
Then the screen returns to the beginning of the manage Access Menu.

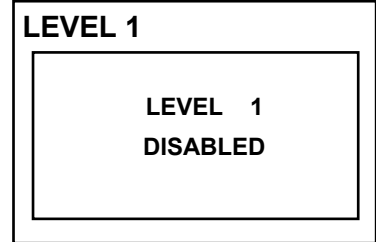

**MODIF. PASSWORD:** This item allows you to **modify the password**, of the corresponding level of access.

Press  on its item. Will appear, the screen where you will be asked to enter before the old password and then the new one.

If the old password was wrong, the window alert you of the error and then return to the screen for entering the password.

If the operation is correct, after entering the new password, the window inform you that the operation has been successful. ----->

Then the screen will return the beginning of managing access to menus.

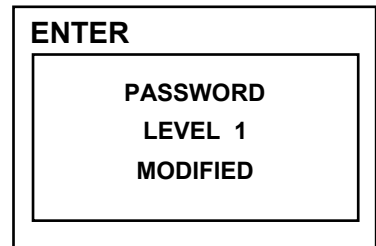

 *If the password of an access level were lost or forgotten, you can change it by entering the password, of a higher access level.*

**Example:** *if it had been lost the password for level 1, you can change it by inserting, instead of the old one, the password for level 2 or level 3.*

 ***After programming, you may want to enter the new password for Level 1 and Level 2. When you enter the new password, remember to write them down and keep them in a safe place. In case of loss of password, please contact Our customer service.***



***This procedure must be performed with extreme caution, by authorized and trained personnel, as they are activated, the relay outputs, which activate the devices connected to both the internal functions of the central.***

## SERVICE

In this submenu you can manage the maintenance of the unit. ----->

SERVICE	
1	<b>ELECTRIC TEST</b>
2	BATTERY
3	SENSORS STATUS
4	START-UP

**ELECTRIC TEST (Level 2):** Pressing on the relevant item, submenu will appear where you can choose which tests to perform. ---->

ELECTRIC TEST	
1	<b>DISPLAY</b>
2	KEYBOARD
3	LEDS/BUZZER
4	OUTPUTS
5	AUX
6	SD CARD

To start a test, press on its item:

- **DISPLAY:** Check the display operation, all the pixels are lit in sequence. After 3 seconds, return to the previous screen.
- **KEYBOARD:** Check the key operation. Will appear the screen with the name of the keys, such as places in the keyboard. When a key is pressed, the display is shown the corresponding name.

To return to the previous screen press twice.

- **LED/BUZZER:** Check the operation of the LEDs and buzzer. First, the LEDs switches off, and then turn them on in sequence, Yellow, Green and Red, then for 1 second activate the buzzer. Then automatically returns to the previous screen.

- **OUTPUTS:** Check the operation of the relay outputs. Are displayed, the numbers of all the relays. Those closed (*positive safety*), are displayed in bold. With and key, moves the cursor to the desired relay, pressing the button will change its state. To exit, press .

This test also checks the output boards. The outputs that are not installed are not displayed.

- **AUX:** Check the operation of the Logic Input. Appears on the display its status, i.e., if the contact is **OPEN** or **CLOSED**.

Press to return to the previous screen.

- **SD CARD:** checks the presence of the memory card. The display shows if the SD Card is **present** or **absent**. *If the SD Card was inserted and was not detected, the card may be not properly inserted or the card's slot is faulty.*

Press to return to the previous screen.

**BATTERY (Level 2):** Pressing on the relevant item, you can choose it, if the battery is installed, or manually perform the function test and display the battery voltage.

Then with and keys, you can choose the item to edit.

Pressing you can change the value using the and key. -->

After choosing the desired value, press to confirm or press to go back.

BATTERY	
PRES. BATT.	<b>NO</b>
TEST BATT :	NO
V.BATT. :	27,51







***The battery test is automatically performed every day. If there is no voltage, the battery test cannot be executed and will be suspended if it is in progress***



***The control unit will be automatically powered by the battery, in the event of mains failure. If the voltage of the battery falls below 22 VDC, the control unit will automatically shut down to prevent damage to the battery (discharging). When the mains supply is present, the battery is charged and kept charged.***

**PRES. BAT. (Presence Battery):**

- When set **NO**, the battery is not present. *In the main screen, the icon in the bottom left will be absent and if there is no mains power, the control panel will shut down.*
- When set **YES**, indicating the presence of the battery. *In the main screen, the icon in the bottom left indicates the charge status of the battery according to the following scheme:*
  -  : Battery full charge. The battery voltage is greater than 26.5 VDC.
  -  : Battery partially charges. The battery voltage is between 24 VDC and 26.5 VDC.
  -  : Battery half charge. The battery voltage is between 24 VDC and 22 VDC.
  -  : Battery discharge. The battery voltage is 20.7 VDC and 22 VDC.
  -  (Flashing): Battery Fault. The battery voltage is below 20.7 VDC or greater than 28 VDC. The battery is considered faulty and is no longer charged. So you will need to replace the two batteries.





**TEST BAT. (Test Battery):**

- When set **YES**, it is activated or indicates that the test is in progress. The test takes about a minute, and checks, with a load, the proper functioning of the battery. If during the test, the battery voltage drops below 20.7 VDC, is reported as a **Fault** (see above), and the battery will not be recharged. **The test will not be activated in the absence of mains or battery.**
- When set **NO**, the test indicates that you disable or do not on the battery test.



When the Battery Test is active, on the power board, placed in the base of the housing, its LED will light, (**BAT TEST ON**). Consider that the two power resistors (load) will heat up during the test.

**SENSORS STATUS (Level 2):** This item allows you to view the current value of the sensors connected to the analog inputs.

Press  on the relevant item. You will see input sensors value, in current (mA), using  and  key, to scroll through the sensors. ----->  
To go back, press .

**SENSORS STATUS**

- 1) 04.00 mA
- 2) 05,23 mA
- 3) 04,05 mA
- 4) 12,38 mA
- 5) 12,00 mA
- 6) 11,58 mA



If the board ES404, had not been installed, the displayed values of the corresponding inputs, should not be considered, normally remain at zero. Consider that, for all the values shown, the two digits after the decimal point may fluctuate.

**START-UP (Level 3):** This submenu is not accessible, is reserved for the factory test.

**SD CARD** In this submenu you can manage the SD card after it has been inserted in its slot. The card slot is on the circuit, in the housing cover. ----->



The SD Card compatible, are **SD** and **SDHC** cards **up to 32GB**. The **SDXC** card must be formatted with **FAT32** (max 32GB). Normally, the unit accepts all SD Card, it is advisable to use those qualified producers.



**SD CARD****1 UPDATE FIRMWA.**

**UPDATE FIRMWA. (Level 2):** This item allows you to **update the firmware** of the unit, using an update file previously saved on an SD Card. The file must be downloaded from our website "[www.tecnoccontrol.it](http://www.tecnoccontrol.it)" in **DOWNLOAD > SOFTWARE > Firmware Update CE408** and then follow the instructions.

Pressing  on the relevant item, you will see what to do before you start the upgrade procedure.



First, move the jumper JP3 in position "**CLOSED**" and then insert the SD card into its slot (see below figure 6).

Then press  to start the update, or press  to go back. ----->

**UPDATE FIRMWARE**

INSERT IN THE  
CONTROL UNIT  
THE JUMPER JP3  
THE SD CARD  
AND PRESS ENTER



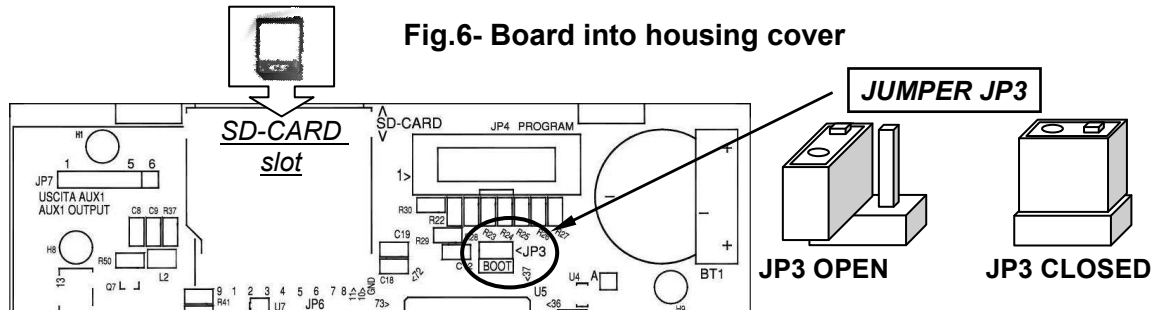

**Fig.6- Board into housing cover**

**i** The update can also be done without going into the menu, simply restarting the unit, after performing the above operations

**!** **Only if the above procedure is correct the unit will restart. Otherwise the system is not continuing.**  
 The control unit checks that the SD card this card is a valid file for the update. If there was more than one, the file is loaded with the latest version.

When the Unit restarts, it starts the automatic update of firmware, the duration of which is about 3 to 4 minutes. This phase is indicated by a flashing yellow LED and a display message. ----->

If there is no any file in the SD Card, or there was a previous version of the firmware or equal to the one already installed, the control panel will report it and then reboot without upgrades. ----->

If the SD Card is unreadable, the panel will report it and then reboot normally. ----->

If the SD Card, it had not been inserted or cannot be detected, the control panel will report it and then reboot normally. Check that you have correctly inserted the card, and if necessary check its operation using the test (see **menu Service → Electric Test → SDCard**).----->

After the upgrade, a message will confirm that the transaction is completed, in addition will be switched on for 3 seconds, the green LED and buzzer. Then the panel will restart in normal operation.----->

**i** **Replace the jumper JP3 in position "OPEN",** if not, every time you restart, and the panel will check if there is an update file on the SD card.

If the update was not successful, the display informs you that the operation has failed, and for 3 seconds to turn on, the red LED and buzzer. Then it will automatically restart in normal operation, but with the previous firmware version.----->

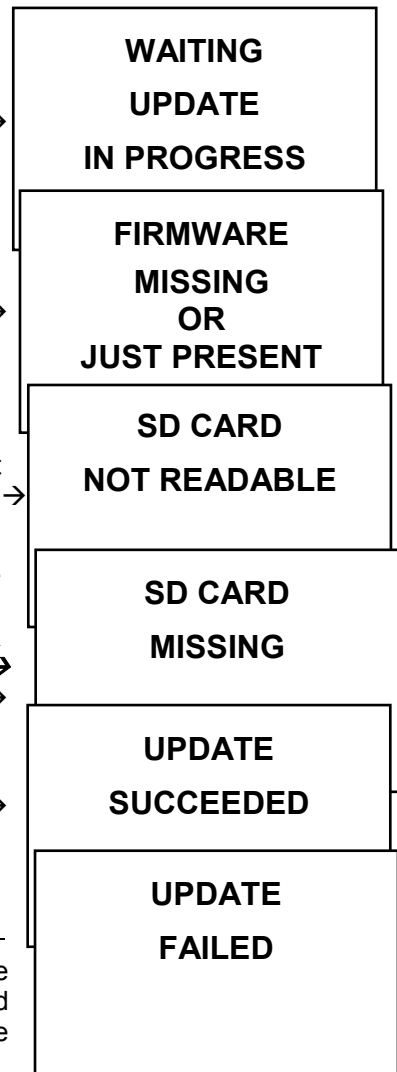

**!** If any errors occur during the upgrade, the firmware may be incomplete. This event will be signaled by the message, **FIRMWARE CORRUPT** that appears when you restart the control unit. In this case, try unpowered and restore power to the control unit and repeat the update. If the problem persists, verify the integrity and correctness of the update file, loading the previous working version of Firmware. Otherwise please contact our customer service.

## APPENDIX

CE408 Technical Specifications	
AC power supply and frequency	90 to 264 VAC / 47 to 63 Hz
AC Maximum consumption <sup>(1)</sup>	1,6A a 110VAC / 1A a 230 VAC
Max current delivered by the power supply	2.7 A at 27.6 VDC
Power consumption at 24VDC <sup>(2)</sup>	30 W Max
Number of detectors that can be connected	Max no. 8
Analog Input 4 to 20 mA (Linear)	8 maximum, of which n.4 factory installed, others are expandable to 8 with expansion board ES404
Analog Input - Load resistance	100 Ohms
Max.Current/Voltage available per input	100 mA / 24 VDC (-10/+15%)
Internal Output relay (with voltage free changeover contacts)	9 maximum, of which n.5 factory installed, expandable to 9 with the expansion board ES414
Nominal load of relay (SPDT contact on each relay)	250 VAC – 2 A or 30 VDC – 2 A resistive load.
Logic inputs	1 (for NA or NO dry contacts)
SD card accepted	SD e SDHC max 32Gb SDXC formatted by PC with FAT32 (max 32Gb).
Display	monochrome LCD graphical display with backlight
Optical indications	n. 3 LEDs (Yellow, Green and Red)
Acoustic indications	Internal Buzzer
Keyboard	8 keys with backlight
Backup battery (optional) <sup>(3)</sup>	n. 2 Pb 12VDC / 1.3Ah (connected in series)
Battery operating time (with 4 sensors) <sup>(4)</sup>	About 80 minutes
Battery operating time (with 8 sensors) <sup>(4)</sup>	About 60 minutes
Temperature of use (with batteries) / Humidity	+5 to +40 °C / 5 to 95% relative humidity
Dimensions and Protection rating.	379x241x133 mm IP42
Weight (without the batteries)	about 2.2 Kg Batteries Weight 1,2 Kg

(1) With all the 8 sensors connected and 9 relays activated.



(2) Max power absorption at 27.6VDC supplied from the power supply (with 8 sensors).

(3) The batteries are not included. If it were required more autonomy, can be used 2 Pb Batteries 12V 3Ah or 7Ah connected in series, but due to their size, they should be installed in an external housing. Autonomy, with 8 sensors becomes: about 2 hours with 3Ah batteries (each sensor in less increases the autonomy of approx 10 min) and about 5 hours with the 7Ah (each sensor in less increases the autonomy of approx 30min .).

(4) Each sensor in less, increases the autonomy of approx 5 minutes (eg, with 6 sensors, the range increases to 10 min.=70 min.).

(5) Using metric cable glands (M16 and M20 Pitch 1.5mm ISO) with appropriate protection rating..

## TABLE with summary of Fault and Alarm messages.

CONDITION	Displaying	Yellow LED	Green LED	RED LED	Buzzer (if configured)
Sensor not Configured	----		Fixed ON		
Sensor (<1mA) or Zone in Fault	FAULT	Fixed ON	Fixed ON		Activated
Sensor or Zone returned from a Fault, but with output relay latched.	NORM (Blinking)	Short blinking <sup>(2)</sup>	Fixed ON		
Sensor operating normally	NORM		Fixed ON		
Battery Operation - (with graphical indication, from Full Charge up to Discharge)			Blinking <sup>(1)</sup>		
Batteries Fault	 Blinking <sup>(1)</sup>	Rapid blinking <sup>(3)</sup>	Fixed ON		
Sensor or Zone or Logic Input, in Alarm 1	AL 1		Fixed ON	Blinking	
Sensor or Zone or Logic Input, in Alarm 2	AL 2		Fixed ON	Blinking	
Sensor or Zone in Alarm 3	AL 3		Fixed ON	Fixed ON	Activated
Sensor or zone or logic input, with Alarm 3 returned to normal, but with relay output latched.	NORM (Blinking)		Fixed ON	Short blinking <sup>(2)</sup>	
Sensor (>24mA) over the Full Scale	F.S.	Fixed ON	Fixed ON	Fixed ON	

(1) Blinking = 1sec ON / 1sec OFF / (2) Short blinking = 0,1sec ON / 1sec OFF / (3) Rapid blinking = 0,1sec ON / 0,1sec OFF

DISPLAY MESSAGE	EXPLICATION	See page
WRONG PASSWORD	Was entered a wrong code level.	<a href="#">29</a>
FIRMWARE CORRUPTED	The CE408P is not able to start, Firmware incomplete or missing	<a href="#">33</a>
UPDATE FAILED	The CE408P is not able to update the firmware from SD-Card	<a href="#">33</a>

**TABLE 1****List of PRECONFIGURED SENSORS with Display and Replaceable Cartridge Sensor**

From Genn. 2017 types TS282xx (IP65) supersede all TS220xx and the TS292xx (Eg. TS292KM becomes TS282KM or the TS220EO becomes TS282EO).

WITH CATALYTIC SENSORS FOR FLAMMABLE GASES					Alarm Levels		
MODELS		GAS	RANGE	UNIT	Threshold 1 (AL1)	Threshold 2 (AL2)	Threshold 3 (AL3)
TS292 KB	TS293KB	PETROL	0÷20	%LIE	7 <sup>(1)</sup>	10	20
TS292 KG	TS293KG	LPG (Butane)					
TS292KI	TS293KI	HYDROGEN					
TS292KM	TS293KM	METHANE					
WITH PELLISTOR SENSORS FOR FLAMMABLE GASES					Alarm Levels		
MODELS		GAS	RANGE	UNIT	Threshold 1 (AL1)	Threshold 2 (AL2)	Threshold 3 (AL3)
TS292PB	TS293PB	PETROL	0-100	%LIE	8 <sup>(1)</sup>	12	20
TS292PG	TS293PG	LPG (Butane)					
	TS293PE	ACETYLENE					
TS292PI	TS293PI	HYDROGEN					
TS292PM	TS293PM	METHANE					
	TS293PS	STYRENE					
TS292PX	TS293PX TS293PX-H	FLAMMABLE					
WITH INFRARED (NDIR) SENSORS FOR FLAMMABLE GASES					Alarm Levels		
MODELS		GAS	RANGE	UNIT	Threshold 1 (AL1)	Threshold 2 (AL2)	Threshold 3 (AL3)
TS293IE		ACETYLENE	0-100	%LIE	8 <sup>(1)</sup>	12	20
TS293IG		LPG (Butane)					
TS293IM		METHANE					
TS293IX		FLAMMABLE					
WITH ELECTROCHEMICAL SENSORS FOR TOXIC GASES					Alarm Levels		
MODELS		GAS	RANGE	UNIT	Threshold 1 (AL1)	Threshold 2 (AL2)	Threshold 3 (AL3)
TS220EA	TS293EA	NH <sub>3</sub>	0-300	ppm	10	20	50
TS220EA-H	TS293EA-H						
TS220EC-S	TS293EC-S	CO	0-300	ppm	25	50	150
TS220 EC-H	TS293 EC-H						
TS220ECL		CL <sub>2</sub>	0-10.0	ppm	0.3	0.5	1.0
TS220EH	TS293EH	H <sub>2</sub> S	0-100	ppm	10	20	50
TS220EHCL		HCL	0-10.0	ppm	3.0	5.0	10.0
TS220EHCN	TS293EHCN	HCN	0-10.0	ppm	2.0	3.0	5.0
TS220EN	TS293EN	NO	0-100	ppm	10	20	50
TS220EN2	TS293EN2	NO <sub>2</sub>	0-30.0	ppm	3.0	6.0	15.0
TS220ES	TS293ES	SO <sub>2</sub>	0-20.0	ppm	5.0	7.5	10.0
WITH ELECTROCHEMICAL SENSORS FOR VITAL GASES					Alarm Levels		
MODELS		GAS	RANGE	UNIT	Threshold 1 (AL1)	Threshold 2 (AL2)	Threshold 3 (AL3)
TS220EO	Alarm = OXYGEN	O <sub>2</sub>	0÷25.0	% vol	19.5	18.5 <sup>(2)</sup>	22.5 <sup>(3)</sup>
TS293EO	Alarm= DECREASING				20.0	19.5	18.5
WITH INFRARED (NDIR) SENSORS FOR ASPHYXIATING GAS					Alarm Levels		
MODELS		GAS	RANGE	UNIT	Threshold 1 (AL1)	Threshold 2 (AL2)	Threshold 3 (AL3)
TS220IC2	TS293IC2	CO <sub>2</sub>	0-5.00	% vol	0.50	1.00	2.00
TS220IC2-H	TS293IC2-H	CO <sub>2</sub>	0-5000	ppm	1000	1800	2500
TS210IC2	IR101/IR102 <sup>(4)</sup>	CO <sub>2</sub>	0-2.00	% vol	0.20	0.50	1
GAS SENSORS WITH TWO SENSORS FOR PARKING					Alarm Levels		
MODELS		GAS	RANGE	UNIT	Threshold 1 (AL1)	Threshold 2 (AL2)	Threshold 3 (AL3)
TS255CB (TS250CB)		CO	0-300	ppm	30	60	150
		Vap.BENZINA	0-20	%LIE	7 <sup>(1)</sup>	10	20
TS255CN2		CO	0-300	ppm	30	60	150
		NO <sub>2</sub>	0-30.0	ppm	3.0	6.0	15.0
WITH SEMICONDUCTOR SENSOR FOR REFRIGERANT GAS					Alarm Levels		
MODELS		GAS	RANGE	UNIT	Threshold 1 (AL1)	Threshold 2 (AL2)	Threshold 3 (AL3)
TS220SFx-H	TS293SFx-H	Refrigerant	0-1000	ppm	400	600	1000

Refrigerant gases: SF1-H (R134a) - SF2-H (R404a) - SF3-H (R407c) SF4-H (R410a) - SF5-H (R507).

### List of PRECONFIGURED SENSORS with Display and Replaceable Cartridge Sensor

WITH PELLISTOR SENSORS FOR FLAMMABLE GASES					Alarm Levels		
MODELS	GAS	RANGE	UNIT	Threshold 1 (AL1)	Threshold 2 (AL2)	Threshold 3 (AL3)	
TS593PX-H	INFIAMMABILI	0-100	%LIE	8 <sup>(1)</sup>	12	20	
WITH INFRARED (NDIR) SENSORS FOR FLAMMABLE GASES					Alarm Levels		
MODELS	GAS	RANGE	UNIT	Threshold 1 (AL1)	Threshold 2 (AL2)	Threshold 3 (AL3)	
TS593IG	GPL (Butano)	0-100	%LIE	8 <sup>(1)</sup>	12	20	
TS593IM	METANO						
WITH ELECTROCHEMICAL SENSORS FOR VITAL GASES					Alarm Levels		
MODELS	GAS	RANGE	UNIT	Threshold 1 (AL1)	Threshold 2 (AL2)	Threshold 3 (AL3)	
TS593EO	Alarm = OXYGEN	O <sub>2</sub>	0÷25.0	% vol	19.5	18.5 <sup>(2)</sup>	22.5 <sup>(3)</sup>
	Alarm= DECREASING				20.0	19.5	18.5

### List of PRECONFIGURED SENSORS without Replaceable Cartridge Sensor

WITH CATALYTIC SENSORS FOR FLAMMABLE GASES					Alarm Levels		
MODELS	GAS	RANGE	UNIT	Threshold 1 (AL1)	Threshold 2 (AL2)	Threshold 3 (AL3)	
SE192 KG SE193 KG	LPG (Butane)	0÷20	%LIE	7 <sup>(1)</sup>	10	20	
SE192KM SE193KM	METHANE						

The SE183K models, are configurable as the corresponding SE193, the only difference is the housing.

**NOTE:** UNIT = Unit of measure

- (1) It is not recommended to set pre-alarm levels lower than the value indicated.
- (2) the Alarm for oxygen deficiency is displayed as **AL.↓**.
- (3) the Alarm for oxygen excess is displayed as **AL.↑**.
- (4) Product discontinued or no longer in stock.

**TABLE 2 – PRECONFIGURED values for TLV**

					Alarm levels		
MODELS		GAS	RANGE	UNIT	TLV-TWA Threshold 1	TLV-STEL Threshold 2	TLV-Ceiling Threshold 3
TS220EA TS293EA TS220EA-H TS293 EA-H	NH <sub>3</sub>	0-300	ppm	25 <sup>(COSH)(OSHA)</sup>	35 <sup>(COSH)</sup>	50 <sup>(OSHA)</sup>	
TS220EC-S TS293 EC-S TS220EC-H TS293 EC-H	CO	0-300	ppm	30 <sup>(COSH)</sup>	200 <sup>(COSH)</sup>	250	
TS220ECL	CL <sub>2</sub>	0-10.0	ppm	0.5 <sup>(OSHA)</sup>	0.5 <sup>(COSH)</sup>	1.0	
TS220EH TS293EH	H <sub>2</sub> S	0-100	ppm	5 <sup>(COSH)</sup>	10 <sup>(COSH)</sup>	20	
TS220EHCL	HCL	0-10.0	ppm	5.0 <sup>(OSHA)</sup>	5.0 <sup>(COSH)</sup>	10.0	
TS220EHCN TS293EHCN	HCN	0-10.0	ppm	4.7 <sup>(OSHA)</sup>	10 <sup>(COSH)</sup>	4.7 <sup>(OSHA)</sup>	
TS220EN TS293EN	NO	0-100	ppm	25 <sup>(COSH)(OSHA)</sup>	25 <sup>(COSH)</sup>	50 <sup>(OSHA)</sup>	
TS220EN2 TS293EN2	NO <sub>2</sub>	0-30	ppm	3.0 <sup>(COSH)</sup>	5.0 <sup>(COSH)</sup>	15.0	
TS220ES TS293ES	SO <sub>2</sub>	0-20.0	ppm	2 <sup>(COSH)</sup>	5 <sup>(COSH)</sup>	10	
TS220IC2 TS293IC2 TS593IC2	CO <sub>2</sub>	0-5.00	% v/v	0.50 <sup>(COSH)(OSHA)</sup>	1.50 <sup>(COSH)</sup>	3.00	
TS210IC2 IR101 / IR102 <sup>(4)</sup>	CO <sub>2</sub>	0-2.00	% v/v	0.50 <sup>(COSH)(OSHA)</sup>	1.50 <sup>(COSH)</sup>	2.00	



The values indicated, refer to the requirements of the institutions that deal about the health of workers. The European Department **COSHH** (Control Of Substances Hazardous to Health) and the U.S. Department **OSHA** (Occupational Safety and Health Administration).

**TABLE 3 – PRECONFIGURED values for use with PARKING-EN (EN50545-1)**

						Alarm levels		
MODELS		GAS	RANGE	Unit of measure	TWA (min.)	Threshold 1 (AL1)	Threshold 2 (AL2)	Threshold 3 (AL3)
TS220EC-S TS293EC-S TS220EC-H TS293EC-H	CO	0-300	ppm	15	30	60	150	
TS220EN TS293EN	NO	0-100	ppm	15	10	20	50	
TS220EN2 TS293EN2	NO <sub>2</sub>	0-30	ppm	15	3.0	6.0	15.0	
TS255CB [TS250CB <sup>(4)</sup> ]	CO	0-300	ppm	15	30	60	150	
TS255CN2	CO	0-300	ppm	15	30	60	150	
	NO <sub>2</sub>	0-30.0	ppm	15	3.0	6.0	15.0	



As indicated in the standard EN50545-1, the **TWA** values, shown in Table 3, can be set from 5 to 60 minutes, while the delay of the relay activation, in **HYST.ON** (Hysteresis ON) **THRESHOLD 3**, can be set from 60 to 300 seconds.

**TABLE 4 – USED ONLY IN ITALY - Values to be set to use with PARKING-ITA (DM 1.02.1986)**

MODELS	GAS	RANGE	Unit of measure	Recommended alarm levels		
				Threshold 1 (AL1)	Threshold 2 (AL2)	Threshold 3 (AL3)
TS220 EC-S TS293EC-S TS220 EC-H TS293 EC-H	CO	0-300	ppm	30	50	100
TS292KB TS293KB	PETROL	0-20	%LEL	7	10	20
TS255CB [TS250CB <sup>(4)</sup> ]	CO	0-300	Ppm	30	50	100
	PETROL	0-20	%LEL	7	10	20



**Only for parking made Italy**, according to DM 12/01/1986, all the sensors for the detection of CO, must be configured with an alarm type INCREASING, and all should be associated to the same zone, setting the logic, as PARK-ING. The THRESHOLD 1 can not be used. The THRESHOLD 2 for the sensor for Petrol vapours can not be used. The output in the THRESHOLD 3 must be configured in the programming of all the individual sensors. The output in the THRESHOLD 2 for CO sensors must be configured in the programming of outputs available for ZONE (OUTPUT\_1\_THRESHOLD\_2, OUTPUT\_2\_SOGLIA\_2).

**TABLE 3 - Relays operation's PRECONFIGURED parameters.**

**SENSORS FOR FLAMMABLE GASES**

Relay Number	ALARM	Silenceable	Hysteresis ON (seconds)	Hysteresis OFF (seconds)	Time ON (seconds)	Positiv Logic	Latched Output
1	AL 1	NO	5	0	0	NO	NO
2	AL 2	NO	10	0	0	NO	NO
3	AL 3	NO	30	0	0	YES	YES
4	FAULT	NO	45	0	0	YES	NO

**SENSORS FOR TOXIC AND ASPHYXIATING GASES (CO<sub>2</sub>)**

Relay Number	ALARM	Silenceable	Hysteresis ON (seconds)	Hysteresis OFF (seconds)	Time ON (seconds)	Positiv Logic	Latched Output
1	AL 1	NO	1	0	0	NO	NO
2	AL 2	NO	5	0	0	NO	NO
3	AL 3	NO	30 <sup>(1)</sup>	0	0	NO	NO
4	FAULT	NO	40	0	0	YES	NO

(1) In the case that the alarm is set to, **PARKING-EN**, this value is equal to "60".

**SENSORS FOR VITAL GASES (Oxygen)**

Relay Number	ALARM	Silenceable	Hysteresis ON (seconds)	Hysteresis OFF (seconds)	Time ON (seconds)	Positiv Logic	Latched Output
1	AL 1	NO	5	0	0	NO	NO
2	AL ↓	NO	10	0	0	YES	YES
3	AL ↑	NO	10	0	0	YES	YES
4	FAULT	NO	30	0	0	YES	NO

## SETUP MEMORANDUM TABLES

*It is recommended to compile these tables, as a reminder of the configuration done. Furthermore these data should be photocopied and attached a copy to the central and other documentation of the plant.*

<b>Inputs (4÷20mA Gas Detectors) configuration</b>								
<u>Sensor Number [1÷8]</u>	1	2	3	4	5 <sup>(1)</sup>	6 <sup>(1)</sup>	7 <sup>(1)</sup>	8 <sup>(1)</sup>
<u>Sensor Model</u>								
<u>Tag</u>								
<b>Type</b> (Flammable, Toxic, Vitale, Refrigerant)								
<b>Gas Detected</b> (Name or Formula)								
<b>Unit of measure</b> (% LEL, %vol, ppm, ppb or °C)								
<b>Full Scale</b> (Max 9.99 oppure 99.9 oppure 9999)								
<b>Alarm Type</b> (Increasing, Decreasing, Oxygen, TLV, Parking-EN)								
<b>Zone</b> (1÷2)								
<b>T.W.A.</b> (Only alarms PARKING-EN)								
<b>Threshold 1</b> (Alarm 1)								
<b>Output 1</b> (Relay Number)								
<b>Threshold 2</b> (Alarm 2)								
<b>Output 2</b> (Relay Number)								
<b>Threshold 3</b> (Alarm 3)								
<b>Output 3</b> (Relay Number)								
<b>Fault</b> (Relay Number)								

<b>Outputs (relays) configuration</b>									
<u>Output Relay Number [1÷9]</u>	1	2	3	4	5 <sup>(2)</sup>	6 <sup>(2)</sup>	7 <sup>(2)</sup>	8 <sup>(2)</sup>	9
<u>Annotation</u>									
<b>Silenceable</b> <sup>(3)</sup> (NO/YES)									
<b>Time of Silence</b> (from 0 to 300 Seconds)									
<b>Hysteresis ON</b> <sup>(4)</sup> (from 0 to 300 Seconds)									
<b>Hysteresis OFF</b> <sup>(5)</sup> (from 0 to 300 Seconds)									
<b>Time ON</b> <sup>(6)</sup> (from 0 to 300 Seconds)									
<b>Positiv Logic</b> (NO/YES)									
<b>Latched output</b> <sup>(7)</sup> (NO/YES)									

<b>Logic input configuration</b>	
<u>Input Number [1]</u>	1
<b>Active</b> (High NO or Low NC)	
<b>Output</b> (Relay Number)	
<b>Silenceable</b> <sup>(3)</sup> (NO/YES)	
<b>Time of Silence</b> (from 0 to 300 Seconds)	
<b>Hysteresis ON</b> <sup>(4)</sup> (from 0 to 300 Seconds)	
<b>Hysteresis OFF</b> <sup>(5)</sup> (from 0 to 300 Seconds)	
<b>Time ON</b> <sup>(6)</sup> (from 0 to 300 Seconds)	
<b>Positiv Logic</b> (NO/YES)	
<b>Latched output</b> <sup>(7)</sup> (NO/YES)	

<b>Zone configuration</b>		
<b>Zone Number [1÷2]</b>	<b>1</b>	<b>2</b>
<b>LOGICA</b> (AND, OR, CORR.CON, CIRC.CON, PARKing-ITA)		
<b>Output 1 threshold 1</b> (Relay Number for AL1)		
<b>Silenceable</b> <sup>(3)</sup> (NO/YES)		
<b>Time of Silence</b> (from 0 to 300 Seconds)		
<b>Hysteresis ON</b> <sup>(4)</sup> (from 0 to 300 Seconds)		
<b>Hysteresis OFF</b> <sup>(5)</sup> (from 0 to 300 Seconds)		
<b>Time ON</b> <sup>(6)</sup> (from 0 to 300 Seconds)		
<b>Positiv Logic</b> (NO/YES)		
<b>Latched output</b> <sup>(7)</sup> (NO/YES)		
<b>Output 2 threshold 1</b> (Relay Number for AL1)		
<b>Silenceable</b> <sup>(3)</sup> (NO/YES)		
<b>Time of Silence</b> (from 0 to 300 Seconds)		
<b>Hysteresis ON</b> <sup>(4)</sup> (from 0 to 300 Seconds)		
<b>Hysteresis OFF</b> <sup>(5)</sup> (from 0 to 300 Seconds)		
<b>Time ON</b> <sup>(6)</sup> (from 0 to 300 Seconds)		
<b>Positiv Logic</b> (NO/YES)		
<b>Latched output</b> <sup>(7)</sup> (NO/YES)		
<b>Output 1 threshold 2</b> (Relay Number for AL2)		
<b>Silenceable</b> <sup>(3)</sup> (NO/YES)		
<b>Time of Silence</b> (from 0 to 300 Seconds)		
<b>Hysteresis ON</b> <sup>(4)</sup> (from 0 to 300 Seconds)		
<b>Hysteresis OFF</b> <sup>(5)</sup> (from 0 to 300 Seconds)		
<b>Time ON</b> <sup>(6)</sup> (from 0 to 300 Seconds)		
<b>Positiv Logic</b> (NO/YES)		
<b>Latched output</b> <sup>(7)</sup> (NO/YES)		
<b>Output 2 threshold 2</b> (Relay Number for AL2)		
<b>Silenceable</b> <sup>(3)</sup> (NO/YES)		
<b>Time of Silence</b> (from 0 to 300 Seconds)		
<b>Hysteresis ON</b> <sup>(4)</sup> (from 0 to 300 Seconds)		
<b>Hysteresis OFF</b> <sup>(5)</sup> (from 0 to 300 Seconds)		
<b>Time ON</b> <sup>(6)</sup> (from 0 to 300 Seconds)		
<b>Positiv Logic</b> (NO/YES)		
<b>Latched output</b> <sup>(7)</sup> (NO/YES)		
<b>Output 1 threshold 3</b> (Relay Number for AL3)		
<b>Silenceable</b> <sup>(3)</sup> (NO/YES)		
<b>Time of Silence</b> (from 0 to 300 Seconds)		
<b>Hysteresis ON</b> <sup>(4)</sup> (from 0 to 300 Seconds)		
<b>Hysteresis OFF</b> <sup>(5)</sup> (from 0 to 300 Seconds)		
<b>Time ON</b> <sup>(6)</sup> (from 0 to 300 Seconds)		
<b>Positiv Logic</b> (NO/YES)		
<b>Latched output</b> <sup>(7)</sup> (NO/YES)		
<b>Output 2 threshold 3</b> (Relay Number for AL3)		
<b>Silenceable</b> <sup>(3)</sup> (NO/YES)		
<b>Time of Silence</b> (from 0 to 300 Seconds)		
<b>Hysteresis ON</b> <sup>(4)</sup> (from 0 to 300 Seconds)		
<b>Hysteresis OFF</b> <sup>(5)</sup> (from 0 to 300 Seconds)		
<b>Time ON</b> <sup>(6)</sup> (from 0 to 300 Seconds)		
<b>Positiv Logic</b> (NO/YES)		
<b>Latched output</b> <sup>(7)</sup> (NO/YES)		





